

Home Cinema 4010 User's Guide

Contents

Home Cinema 4010 User's Guide	9
Introduction to Your Projector	10
Projector Features.....	10
Product Box Contents.....	11
Additional Components	12
Optional Equipment and Replacement Parts.....	12
Warranty and Registration Information	13
Notations Used in the Documentation	13
Where to Go for Additional Information	14
Additional Projector Software and Manuals.....	14
Projector Part Locations	15
Projector Parts - Front/Top	16
Projector Parts - Rear	17
Projector Parts - Base.....	18
Projector Parts - Control Panel	19
Projector Parts - Remote Control.....	20
Setting Up the Projector	22
Projector Placement.....	22
Projector Setup and Installation Options	22
Projection Distance.....	24
Projector Connections	27
Connecting to an HDMI Video Source	27
Connecting to Computer Sources.....	28
Connecting to a Computer for VGA Video.....	28
Connecting to a Computer for HDMI Video	28
Attaching and Removing the Cable Clips	29
Connecting to External Speakers	30
Connecting to a Trigger Out Port.....	30
Installing Batteries in the Remote Control	31

Using the Projector on a Network	33
Wired Network Projection	33
Connecting to a Wired Network	33
Selecting Wired Network Settings	34
Wireless Network Projection	36
Installing the Wireless LAN Module	37
Selecting Wireless Network Settings Manually	38
Wireless LAN Menu Settings	41
Restricted IP Addresses	42
Using a QR Code to Connect a Mobile Device	42
Searching for a Wireless Network	44
Selecting Wireless Network Settings in Windows	46
Selecting Wireless Network Settings on Mac	46
Enabling WPA or WPA2 Security	46
Wireless Security Menu Settings	47
Selecting External Network Detection Settings	48
Using Basic Projector Features	50
Turning On the Projector	50
Using the Home Screen	51
Turning Off the Projector	53
Viewing 3D Images	54
Pairing the 3D Glasses with the Projector	55
Charging the 3D Glasses	56
3D Viewing Range	58
Selecting the Language for the Projector Menus	58
Adjusting the Image Height	59
Adjusting the Image Position Using Lens Shift	60
Image Shape	62
Correcting Image Shape With the Keystone Buttons	62
Resizing the Image with the Zoom Feature	62
Focusing the Image with the Lens Button	63
Remote Control Operation	64
Selecting an Image Source	65

Projection Modes	67
Changing the Projection Mode Using the Menu	67
Image Aspect Ratio	68
Changing the Image Aspect Ratio	69
Available Image Aspect Ratios	69
Color Mode.....	70
Changing the Color Mode.....	70
Available Color Modes.....	71
Turning On Auto Iris.....	71
Adjusting Projector Features	73
Shutting Off the Picture Temporarily	73
Using Picture in Picture	73
Available Picture in Picture Options.....	74
Projector Security Features.....	75
Locking the Projector's Lens Settings and Buttons.....	75
Unlocking the Projector's Buttons	76
Installing a Security Cable	77
Using Advanced Image Adjustment Features	77
Using Frame Interpolation	77
Using 4K Enhancement.....	78
Creating Image Presets.....	80
Using MPEG Noise Reduction.....	81
Adjusting Scaled Resolution Images (Super-resolution)	82
Adjusting Detail Enhancement	83
Image Adjustment Restrictions.....	84
Adjusting the Color Convergence (Panel Alignment).....	85
Adjusting the Color Tone (Color Uniformity)	89
Saving Settings to Memory and Using Saved Settings	91
Saving the Lens Position and Using Saved Lens Positions.....	92
Adjusting the Menu Settings	95
Using the Projector's Menu.....	95
Image Quality Settings - Image Menu	96
Input Signal Settings - Signal Menu.....	101

Projector Feature Settings - Settings Menu.....	104
Projector Setup Settings - Extended Menu.....	107
Projector Network Settings - Network Menu.....	109
Projector Information Display - Info Menu	111
Event ID Code List.....	112
Projector Reset Options - Reset Menu.....	114
Maintaining and Transporting the Projector	116
Projector Maintenance	116
Cleaning the Lens.....	116
Cleaning the Projector Case.....	117
Cleaning the 3D Glasses	117
Air Filter and Vent Maintenance	118
Cleaning the Air Filter.....	118
Replacing the Air Filter.....	121
Projector Lamp Maintenance.....	123
Replacing the Lamp	124
Resetting the Lamp Timer.....	127
Replacing the Remote Control Batteries	128
Transporting the Projector.....	130
Solving Problems	131
Projection Problem Tips	131
Projector Light Status	132
Solving Image Problems	135
Solutions When No Image Appears.....	135
Solutions When "No Signal" Message Appears.....	136
Displaying From a PC Laptop	137
Displaying From a Mac Laptop	137
Solutions When "Not Supported" Message Appears	137
Solutions When Only a Partial Image Appears.....	138
Solutions When the Image is Not Rectangular	138
Solutions When the Image Contains Noise or Static	139
Solutions When the Image is Fuzzy or Blurry	140
Solutions When the Image Brightness or Colors are Incorrect	141

Solutions When a 3D Image Does Not Display Correctly	141
Solving Projector or Remote Control Operation Problems	142
Solutions to Projector Power or Shut-Off Problems	143
Solutions to Problems with the Remote Control.....	144
Solutions to Panel Alignment Problems	144
Solutions When Using HDMI Link.....	145
Solutions When Wireless Authentication Fails	145
Where to Get Help.....	146
Technical Specifications	147
General Projector Specifications	147
Projector Lamp Specifications	148
Remote Control Specifications	149
Projector Dimension Specifications.....	149
Projector Electrical Specifications	149
Projector Environmental Specifications.....	150
Projector Safety and Approvals Specifications	150
Supported Video Display Formats.....	151
Notices	153
Recycling.....	153
Important Safety Information	153
Important Safety Instructions.....	154
Restriction of Use	156
List of Safety Symbols	157
FCC Compliance Statement.....	160
Binding Arbitration and Class Waiver	161
Trademarks	164
Copyright Notice.....	165
A Note Concerning Responsible Use of Copyrighted Materials.....	165
Copyright Attribution	166

Home Cinema 4010 User's Guide

Welcome to the Home Cinema 4010 *User's Guide*.

For a printable PDF copy of this guide, [click here](#).

Introduction to Your Projector

Refer to these sections to learn more about your projector and this manual.

[Projector Features](#)

[Notations Used in the Documentation](#)

[Where to Go for Additional Information](#)

[Additional Projector Software and Manuals](#)

[Projector Part Locations](#)

Projector Features

The Home Cinema 4010 projector includes these special features:

Bright, high-resolution projection system

- Up to 2400 lumens of color brightness (color light output) and 2400 lumens of white brightness (white light output)

Note: Color brightness (color light output) and white brightness (white light output) will vary depending on usage conditions. Color light output measured in accordance with IDMS 15.4; white light output measured in accordance with ISO 21118.

- 1080p native resolution with 4K Enhancement
- Images up to 300 inches (7.62 m) for projection on any wall or screen

Full 3D projection

- Active 3D projection with optional RF active shutter glasses
- Supports side-by-side, top-and-bottom, and frame-packing 3D formats

Flexible connectivity

- Two HDMI ports for video device or computer connections
- Support for an optical HDMI connection

Easy-to-use setup and operation features

- Powered vertical and horizontal lens shift, and vertical keystone correction buttons for flexible projector placement
- 2.1× optical zoom ratio for improved zooming capability

- Powered zoom and focus adjustments

[Product Box Contents](#)

[Additional Components](#)

[Optional Equipment and Replacement Parts](#)

[Warranty and Registration Information](#)

Parent topic: [Introduction to Your Projector](#)

Product Box Contents

Save all the packaging in case you need to ship the projector. Always use the original packaging (or equivalent) when shipping.

Make sure your product box included all of these parts:

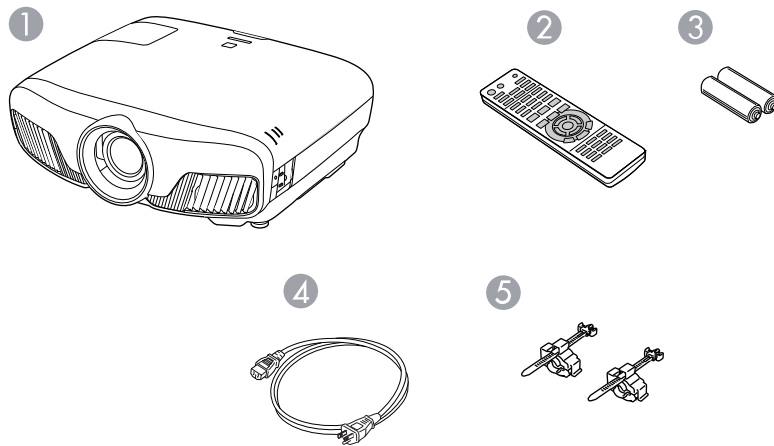

- 1 Projector
- 2 Remote control
- 3 Remote control batteries (two AA alkaline)
- 4 Power cord
- 5 HDMI cable clips (2)

The product box contents may vary by country.

Parent topic: [Projector Features](#)

Additional Components

Depending on how you plan to use the projector, you may need to obtain additional components.

Note: To connect a Mac that does not include a compatible video output port, you need to obtain an adapter that allows you to connect to an input port on the projector. Contact Apple for compatible adapter options. To connect a smartphone or tablet, you may need to obtain an adapter that allows you to connect to the projector. This allows you to mirror your smartphone or tablet screens, watch movies, and more. Contact your device manufacturer for compatible adapter options.

Unless listed as available from Epson in this table, see your local computer or electronics dealer for purchase information.

Signal or connection type	Additional component necessary
HDMI	Compatible HDMI cable Available for purchase from Epson or an authorized Epson reseller.
Optical HDMI	Compatible optical HDMI cable
3D	Compatible HDMI cable and active shutter 3D glasses Available for purchase from Epson or an authorized Epson reseller. Note: If your video source is a 3D Blu-ray disc, you also need a Blu-ray player that supports 3D playback. See your local computer or electronics dealer for purchase information.
External audio	Speakers, an audio video receiver, or a video source with speaker connections, and the cables necessary for connecting them
VGA	To connect a computer through its VGA port to the projector's VGA video port, you need a VGA computer cable. Available for purchase from Epson or an authorized Epson reseller.

Parent topic: [Projector Features](#)

Optional Equipment and Replacement Parts

You can purchase screens, other optional accessories, and replacement parts from an Epson authorized reseller. To find the nearest reseller, call 800-GO-EPSON (800-463-7766) in the U.S. or 800-807-7766 in Canada. Or you can purchase online at epsonstore.com (U.S. sales) or epsonstore.ca (Canadian sales).

Epson offers the following optional accessories and replacement parts for your projector:

Option or part	Part number
Genuine Epson replacement lamp (ELPLP89)	V13H010L89
Replacement air filter	V13H134A39
RF 3D glasses (ELPGS03)	V12H548006
Wireless LAN module (ELPAP10)	V12H731P02
Projector ceiling mount	CHF4000
Belkin PureAV HDMI audio video cable, 6 ft	AV22300-06
Belkin PureAV HDMI audio video cable, 3 ft	AV22300-03

In addition to the accessories listed above, a 1-year extended service plan is available.

Parent topic: [Projector Features](#)

Warranty and Registration Information

Your projector comes with a basic warranty that lets you project with confidence. For details, see the warranty brochure that came with your projector.

In addition, Epson offers free Extra Care Home Service. In the unlikely event of an equipment failure, you won't have to wait for your unit to be repaired. Instead, Epson will ship you a replacement unit anywhere in the United States, Canada, or Puerto Rico. See the Extra Care Home Service brochure for details.

Register your product online at this site: epson.com/webreg

Registering also lets you receive special updates on new accessories, products, and services.

Parent topic: [Projector Features](#)

Notations Used in the Documentation

Follow the guidelines in these notations as you read your documentation:

- **Warnings** must be followed carefully to avoid bodily injury.
- **Cautions** must be observed to avoid damage to your equipment.
- **Notes** contain important information about your projector.
- **Tips** contain additional projection information.

Parent topic: [Introduction to Your Projector](#)

Where to Go for Additional Information

Need quick help on using your projector? Here's where to look for help:

- epson.com/support (U.S.) or epson.ca/support (Canada)

View FAQs (frequently asked questions) and e-mail your questions to Epson technical support 24 hours a day.

- If you still need help after checking this manual and any other sources listed here, you can use the Epson PrivateLine Support service to get help fast. For details, see "Where to Get Help."

Parent topic: [Introduction to Your Projector](#)

Related references

[Where to Get Help](#)

Additional Projector Software and Manuals

After connecting and setting up the projector, install the projector software. You may need to install it from a software CD, if included, or download the software and manuals as necessary.

You can install the projector software programs listed here and view their manuals for instructions on using them.

Note: If you still need help after checking this manual and the sources listed here, you can use the Epson PrivateLine Support service to get help fast. For details, see "Where to Get Help."

Projector software	Manual	Description
Epson iProjection (Windows/Mac)	<i>Epson iProjection Operation Guide (Windows/Mac)</i>	Lets you project the computer screens of users over a network. You can download the latest software and documentation from the Epson web site. Go to epson.com/support (U.S.) or epson.ca/support (Canada) and select your projector.

Projector software	Manual	Description
Epson iProjection app	Instructions are included with the app	Lets you project from an iOS or Android device if your projector is connected to a network that includes a wireless access point. Visit epson.com/iprojection (U.S.) or epson.ca/iprojection (Canada) for more information.
—	<i>Open Source Software License</i>	You can download this document from the Epson web site. Go to epson.com/support (U.S.) or epson.ca/support (Canada) and select your projector.

Parent topic: [Introduction to Your Projector](#)

Related references

[Where to Get Help](#)

Projector Part Locations

Check the projector part illustrations to learn about the parts on your projector.

[Projector Parts - Front/Top](#)

[Projector Parts - Rear](#)

[Projector Parts - Base](#)

[Projector Parts - Control Panel](#)

[Projector Parts - Remote Control](#)

Parent topic: [Introduction to Your Projector](#)

Projector Parts - Front/Top

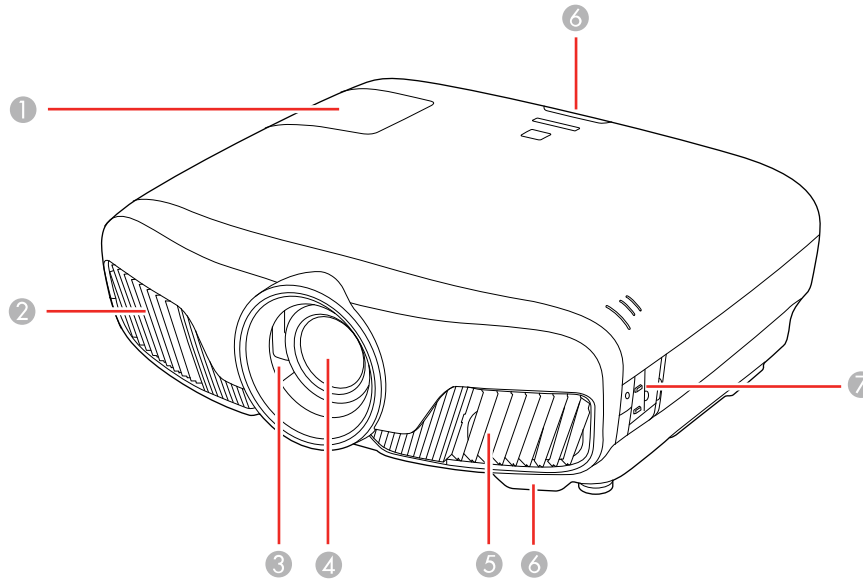

- 1 Lamp cover
- 2 Exhaust vent
- 3 Lens shutter
- 4 Lens
- 5 Air intake/air filter cover
- 6 Remote receivers
- 7 Control panel

Parent topic: [Projector Part Locations](#)

Projector Parts - Rear

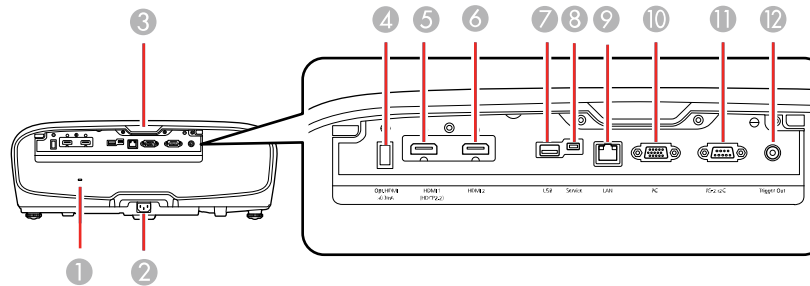

- 1 Security slot
- 2 AC input port
- 3 Remote receiver
- 4 **Opt.HDMI (300mA)** port (USB power for optical HDMI connections)
- 5 **HDMI1 (HDCP 2.2)** port
- 6 **HDMI2** port
- 7 **USB** port (for optional wireless LAN module and firmware updates)
- 8 **Service** port
- 9 **LAN** port
- 10 **PC** port (VGA)
- 11 **RS-232C** port
- 12 **Trigger Out** port (12V DC @ 200 mA max)

Parent topic: [Projector Part Locations](#)

Related tasks

[Installing a Security Cable](#)

[Attaching and Removing the Cable Clips](#)

Projector Parts - Base

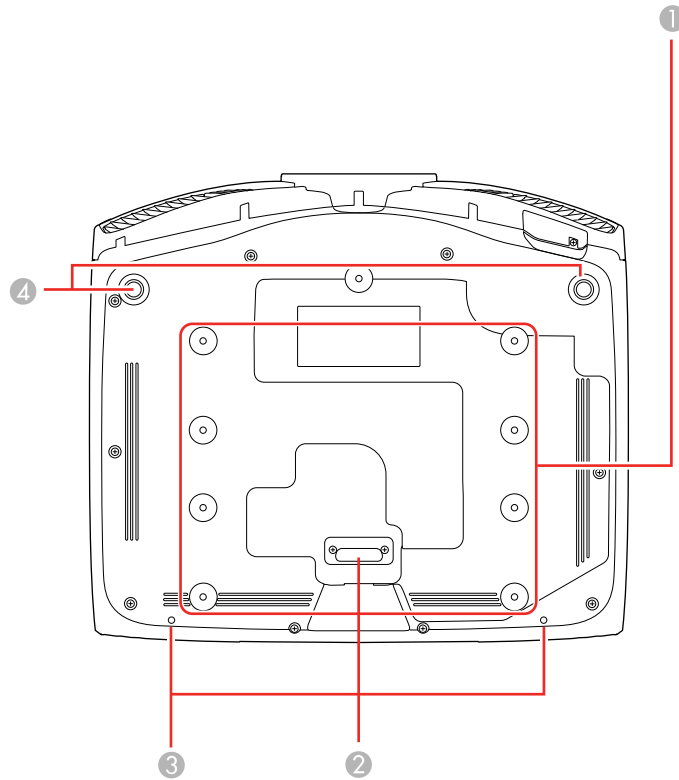

- 1 Mounting bracket holes (M4x9)
- 2 Rear foot
- 3 Cable cover screw holes
- 4 Front adjustable feet

Parent topic: [Projector Part Locations](#)

Projector Parts - Control Panel

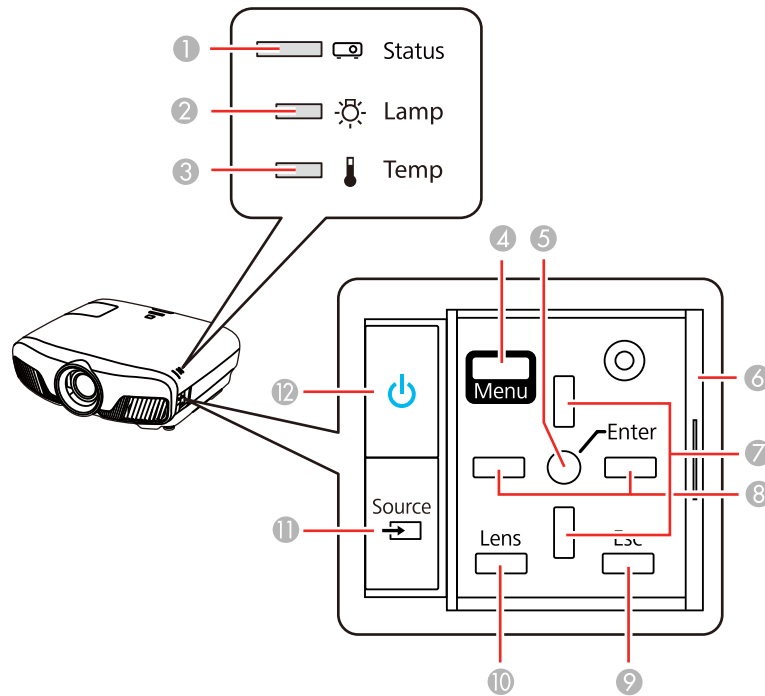

- 1 **Status** light
- 2 **Lamp** light
- 3 **Temp** light
- 4 **Menu** button (accesses projector menu system)
- 5 **Enter** button (selects options)
- 6 Control panel cover
- 7 Vertical keystone adjustment buttons (adjust screen shape) and arrow buttons
- 8 Arrow buttons
- 9 **Esc** button (cancels/exits functions)
- 10 **Lens** button (cycles through lens adjustment options)
- 11 **Source** button (cycles through the list of sources)

12 Power button/light

Parent topic: [Projector Part Locations](#)

Projector Parts - Remote Control

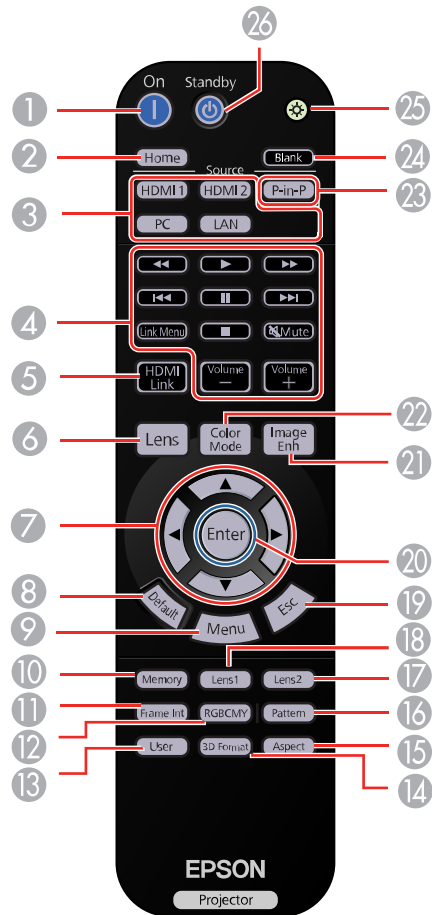

- 1 **On** button (turns on projector)
- 2 **Home** button (displays Home screen)

- 3 Source buttons (select specific video input sources)
- 4 **Link Menu** button (displays the main menu of the connected device)
Control buttons (control playback and other features of connected devices that support the HDMI CEC standard)
- 5 **HDMI Link** button (displays the settings menu for HDMI Link)
- 6 **Lens** button (cycles through lens adjustment options)
- 7 Arrow buttons (move through on-screen options)
- 8 **Default** button (returns selected setting to default value)
- 9 **Menu** button (accesses projector menu system)
- 10 **Memory** button (accesses the Memory menu)
- 11 **Frame Int** button (adjusts the Frame Interpolation setting)
- 12 **RGBCMY** button (adjusts hue, saturation, and brightness for each RGBCMY color)
- 13 **User** button (customizable for different functions)
- 14 **3D Format** button (changes the 3D format)
- 15 **Aspect** button (selects the image aspect ratio)
- 16 **Pattern** button (displays a test pattern)
- 17 **Lens2** button (loads the second saved lens position)
- 18 **Lens1** button (loads the first saved lens position)
- 19 **Esc** button (cancels/exits functions)
- 20 **Enter** button (selects options)
- 21 **Image Enh** button (displays the **Image Enhancement** menu)
- 22 **Color Mode** button (selects display modes)
- 23 **P-in-P** button (controls the Picture-in-Picture mode)
- 24 **Blank** button (turns off video projection)
- 25 Illumination button (lights the remote control)
- 26 **Standby** button (turns off the projector)

Parent topic: [Projector Part Locations](#)

Setting Up the Projector

Follow the instructions in these sections to set up your projector for use.

[Projector Placement](#)

[Projector Connections](#)

[Installing Batteries in the Remote Control](#)

Projector Placement

You can place the projector on almost any flat surface to project an image.

You can also install the projector in a ceiling mount if you want to use it in a fixed location.

Keep these considerations in mind as you select a projector location:

- Place the projector on a sturdy, level surface or install it using a compatible mount.
- Leave plenty of space around and under the projector for ventilation, and do not place it on top of or next to anything that could block the vents.
- Place the projector parallel to the screen.
- Position the projector within reach of a grounded electrical outlet or extension cord.

[Projector Setup and Installation Options](#)

[Projection Distance](#)

Parent topic: [Setting Up the Projector](#)

Related tasks

[Changing the Projection Mode Using the Menus](#)

Projector Setup and Installation Options

You can set up or install your projector in the following ways:

Front

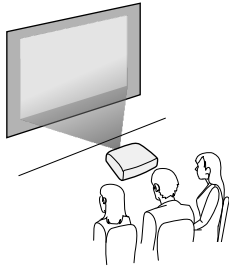

Rear

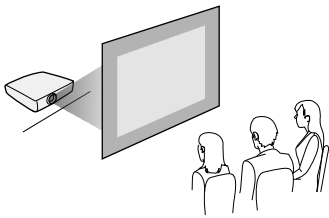

Front Ceiling

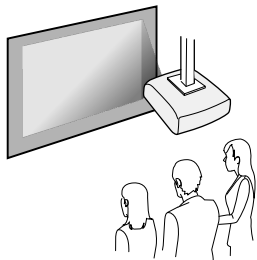

Rear Ceiling

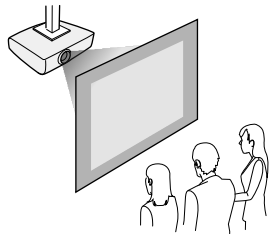

Wherever you set up the projector, make sure to position it squarely in front of the center of the screen, not at an angle, if possible. If the projector cannot be centered in front of the screen, use lens shift to reposition the image instead of using keystone correction for better image quality.

If you project from the ceiling or from the rear, be sure to select the correct **Projection** option in the projector's menu system.

Parent topic: [Projector Placement](#)

Related references

[Projector Setup Settings - Extended Menu](#)

Projection Distance

The distance at which you place the projector from the screen determines the approximate size of the image. The image size increases the farther the projector is from the screen, but can vary depending on the zoom factor, aspect ratio, and other settings.

Use the tables here to determine approximately how far to place the projector from the screen based on the size of the projected image. (Conversion figures may have been rounded up or down.)

You can also use the projector Throw Distance Calculator at epson.com/support (U.S.) or epson.ca/support (Canada).

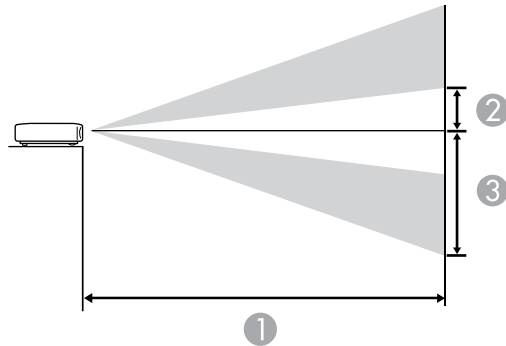

16:9 Aspect Ratio Image or Screen

Screen or image size	Projection distance (1) Wide to Tele	Offset from lens center (2)	Offset from lens center (3)	Horizontal offset from lens center
50 inches (127 cm)	58 to 123 inches (148 to 313 cm)	11.3 inches (29 cm)	35.9 inches (91 cm)	±20.5 inches (52 cm)
60 inches (152.4 cm)	70 to 148 inches (178 to 376 cm)	13.6 inches (35 cm)	43 inches (109 cm)	±24.6 inches (63 cm)
80 inches (203.2 cm)	94 to 198 inches (239 to 630 cm)	18.2 inches (46 cm)	57.4 inches (146 cm)	±32.8 inches (83 cm)
100 inches (254 cm)	118 to 248 inches (300 to 630 cm)	22.7 inches (58 cm)	71.7 inches (182 cm)	±41 inches (104 cm)
150 inches (381 cm)	178 to 373 inches (452 to 947 cm)	34 inches (86 cm)	107.6 inches (273 cm)	±61.6 inches (156 cm)
200 inches (508 cm)	238 to 498 inches (604 to 1264 cm)	45.4 inches (115 cm)	143.4 inches (364 cm)	±82.1 inches (209 cm)

Screen or image size	Projection distance (1) Wide to Tele	Offset from lens center (2)	Offset from lens center (3)	Horizontal offset from lens center
250 inches (635 cm)	297 to 623 inches (756 to 1582 cm)	56.7 inches (144 cm)	179.3 inches (455 cm)	±102.6 inches (261 cm)
300 inches (762 cm)	357 to 748 inches (908 to 1899 cm)	68.1 inches (173 cm)	215.2 inches (547 cm)	±123.1 inches (313 cm)

4:3 Aspect Ratio Image or Screen

Screen or image size	Projection distance (1) Wide to Tele	Offset from lens center (2)	Offset from lens center (3)	Horizontal offset from lens center
50 inches (127 cm)	72 to 151 inches (182 to 384 cm)	13.9 inches (35 cm)	43.9 inches (111 cm)	±25.1 inches (56 cm)
60 inches (152.4 cm)	86 to 182 inches (219 to 462 cm)	16.7 inches (42 cm)	52.7 inches (134 cm)	±30.1 inches (77 cm)
80 inches (203.2 cm)	115 to 243 inches (293 to 617 cm)	22.2 inches (56 cm)	70.2 inches (178 cm)	±40.2 inches (102 cm)
100 inches (254 cm)	145 to 304 inches (368 to 772 cm)	27.8 inches (71 cm)	87.8 inches (223 cm)	±50.2 inches (128 cm)
120 inches (304.8 cm)	174 to 365 inches (442 to 927 cm)	33.3 inches (854 cm)	105.3 inches (268 cm)	±60.3 inches (153 cm)
150 inches (381 cm)	218 to 457 inches (554 to 1160 cm)	41.7 inches (106 cm)	131.7 inches (334 cm)	±75.4 inches (191 cm)
200 inches (508 cm)	291 to 610 inches (740 to 1548 cm)	55.6 inches (141 cm)	175.6 inches (446 cm)	±100.5 inches (255 cm)
220 inches (558.8 cm)	321 to 671 inches (814 to 1704 cm)	61.1 inches (155 cm)	193.1 inches (491 cm)	±110.5 inches (281 cm)

Screen or image size	Projection distance (1) Wide to Tele	Offset from lens center (2)	Offset from lens center (3)	Horizontal offset from lens center
244.8 inches (622 cm)	357 to 746 inches (906 to 1896 cm)	68 inches (173 cm)	214.8 inches (546 cm)	±123 inches (312 cm)

Parent topic: [Projector Placement](#)

Projector Connections

See these sections to connect the projector to a variety of projection sources.

Caution: If you will use the projector at altitudes above 4921 feet (1500 m), turn on **High Altitude Mode** to ensure the projector's internal temperature is regulated properly.

[Connecting to an HDMI Video Source](#)

[Connecting to Computer Sources](#)

[Attaching and Removing the Cable Clips](#)

[Connecting to External Speakers](#)

[Connecting to a Trigger Out Port](#)

Parent topic: [Setting Up the Projector](#)

Related references

[Projector Setup Settings - Extended Menu](#)

Connecting to an HDMI Video Source

If your video source has an HDMI port, you can connect it to the projector using an optional HDMI cable. The HDMI connection provides the best image quality.

1. Connect the HDMI cable to your video source's HDMI output port.
2. Connect the other end to one of the projector's HDMI ports. If you are connecting an optical HDMI cable, you must also connect the cable's USB power connector to the **Opt.HDMI (300mA)** port.

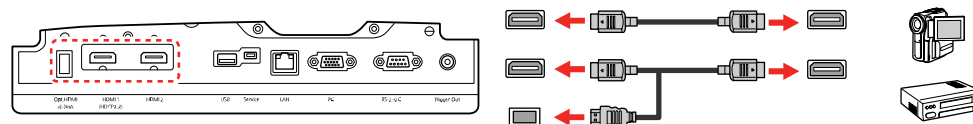

Note: When an audio/video source that meets the HDMI CEC standard is connected to the projector's HDMI port, you can use the projector's remote control to control certain features of the linked device by pressing the **HDMI Link** button on the remote control and setting **HDMI Link** to **On**.

Parent topic: [Projector Connections](#)

Connecting to Computer Sources

Follow the instructions in these sections to connect a computer to the projector.

[Connecting to a Computer for VGA Video](#)

[Connecting to a Computer for HDMI Video](#)

Parent topic: [Projector Connections](#)

Connecting to a Computer for VGA Video

You can connect the projector to your computer using a VGA computer cable.

Note: To connect a Mac that does not include a compatible video output port, you need to obtain an adapter that allows you to connect to an input port on the projector. Contact Apple for compatible adapter options. To connect a smartphone or tablet, you may need to obtain an adapter that allows you to connect to the projector. This allows you to mirror your smartphone or tablet screens, watch movies, and more. Contact your device manufacturer for compatible adapter options.

1. If necessary, disconnect your computer's monitor cable.
2. Connect the VGA computer cable to your computer's monitor port.
3. Connect the other end to a **PC** port on the projector.

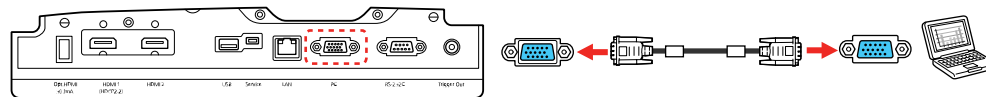

4. Tighten the screws on the VGA connector.

Parent topic: [Connecting to Computer Sources](#)

Connecting to a Computer for HDMI Video

If your computer has an HDMI port, you can connect it to the projector using an optional HDMI cable.

Note: To connect a Mac that does not include a compatible video output port, you need to obtain an adapter that allows you to connect to an input port on the projector. Contact Apple for compatible adapter options. To connect a smartphone or tablet, you may need to obtain an adapter that allows you to connect to the projector. This allows you to mirror your smartphone or tablet screens, watch movies, and more. Contact your device manufacturer for compatible adapter options.

1. Connect the HDMI cable to your computer's HDMI output port.
2. Connect the other end to one of the projector's HDMI ports. If you are connecting an optical HDMI cable, you must also connect the cable's USB power connector to the **Opt.HDMI (300mA)** port.

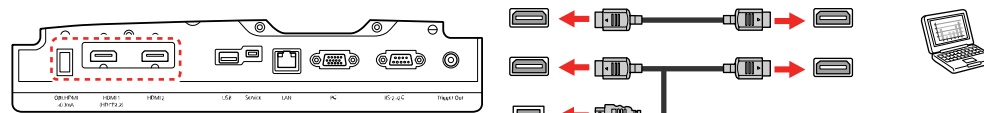

Parent topic: [Connecting to Computer Sources](#)

Attaching and Removing the Cable Clips

You can install the cable clips that came with your projector to provide additional support to the HDMI cables.

1. Plug in the HDMI cables.
2. Insert each guide into the cable clip holes near the **HDMI** port.
3. Attach the cable clips to the HDMI cables. Be sure to leave the clamps unlocked.
4. Slide each cable clip onto the guides and lock the clamps onto the connectors.

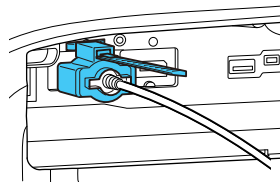

To remove the cable clips, open the clamps and disconnect the cables. Then pinch the sides of each guide and carefully pull them out of the cable clip holes.

Parent topic: [Projector Connections](#)

Connecting to External Speakers

To add sound, you can connect your video source and speakers to an audio video receiver, then connect the receiver to the projector using one of the receiver's compatible video outputs (an HDMI connection provides the best image quality, if available). You can also connect speakers to any video source that has its own speaker connections.

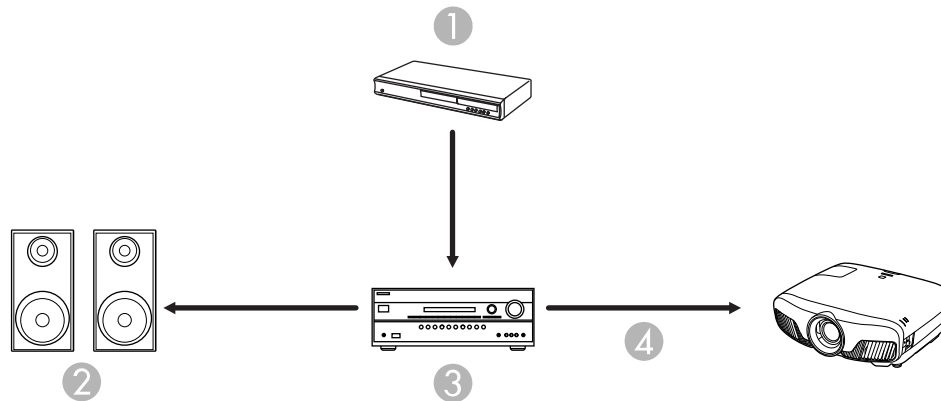

- 1 Video source
- 2 Surround sound speakers
- 3 Receiver
- 4 Video cable

Parent topic: [Projector Connections](#)

Connecting to a Trigger Out Port

You can connect your projector to external devices such as motorized screens that support a trigger signal. When active, a 12V (200 mA maximum) signal is sent to the connected device while the projector is powered on.

1. Connect a 3.5 mm stereo mini-jack cable to the external device's trigger port. See your device's documentation for details.

2. Connect the other end to the projector's **Trigger Out** port.

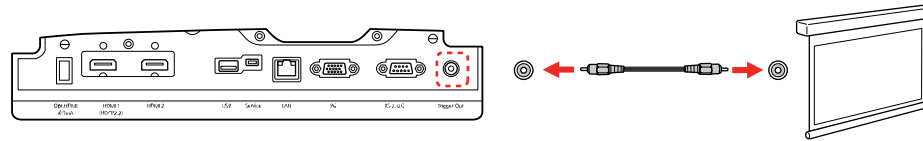

3. Turn on the **Trigger Out** setting in the projector's **Extended** menu.

Parent topic: [Projector Connections](#)

Related references

[Projector Setup Settings - Extended Menu](#)

Installing Batteries in the Remote Control

The remote control uses the two AA batteries that came with the projector.

Caution: Use only the type of batteries specified in this manual. Do not install batteries of different types, or mix new and old batteries.

1. Remove the battery cover.

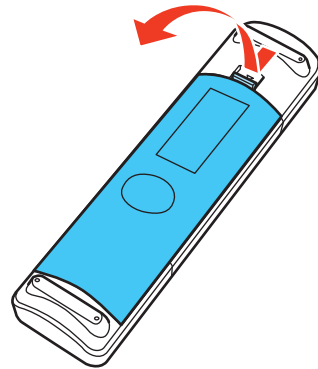

2. Insert the batteries with the + and – ends facing as shown.

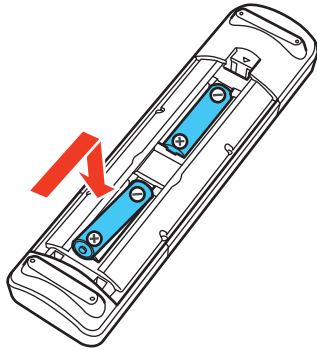

3. Replace the battery cover and press it down until it clicks into place.

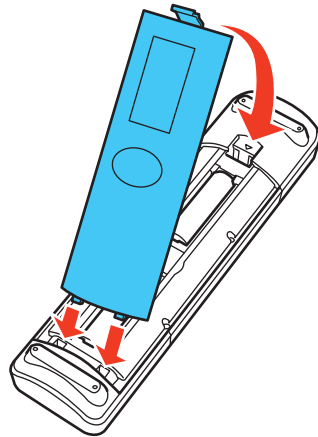

Warning: Dispose of used batteries according to local regulations. Do not expose batteries to heat or flame. Keep batteries out of the reach of children; they are choking hazards and are very dangerous if swallowed.

Parent topic: [Setting Up the Projector](#)

Related references

[Remote Control Specifications](#)

Using the Projector on a Network

Follow the instructions in these sections to set up your projector for use on a network.

Note: Epson iProjection is not recommended for use with streaming video.

[Wired Network Projection](#)

[Wireless Network Projection](#)

[Selecting External Network Detection Settings](#)

Wired Network Projection

You can project through a wired network. To do this, you connect the projector to your network with an Ethernet cable, and then set up your projector and computer for network projection.

After connecting and setting up the projector, install the projector software. You may need to install it from a software CD, if included, or download the software and manuals as necessary.

Note: If your projector is connected via a LAN (Ethernet) cable to a network that includes a wireless access point, you can connect to the projector wirelessly through the access point using the Epson network software.

[Connecting to a Wired Network](#)

[Selecting Wired Network Settings](#)

Parent topic: [Using the Projector on a Network](#)

Related references

[Additional Projector Software and Manuals](#)

Connecting to a Wired Network

To connect the projector to a wired local area network (LAN), use a 100Base-TX or 10Base-T network cable. To ensure proper data transmission, use a Category 5 shielded cable or better.

1. Connect one end of the network cable to your network hub, switch, or router.

2. Connect the other end of the cable to the projector's **LAN** port.

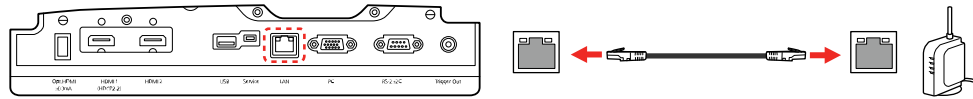

Parent topic: [Wired Network Projection](#)

Selecting Wired Network Settings

Before you can project from computers, tablets, or smartphones over your network, you must select the network settings for the projector using its menu system.

Note: Make sure you already connected the projector to your wired network using the **LAN** port.

1. Turn on the projector.
2. Press the **Menu** button.
3. Select the **Network** menu and press **Enter**.

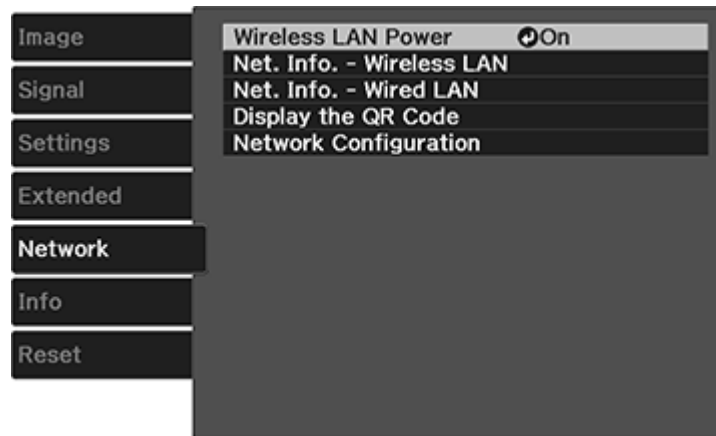

4. Select **Network Configuration** and press **Enter**.

5. Select the **Basic** menu and press **Enter**.

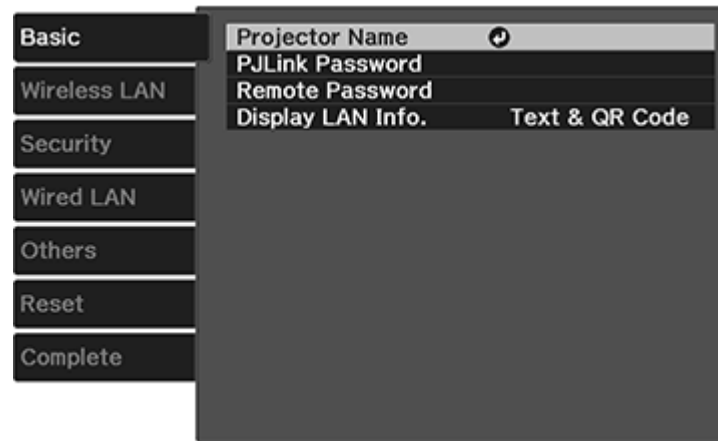

6. Select the following basic options as necessary:
 - **Projector Name** lets you enter a name up to 16 alphanumeric characters long to identify the projector over the network.
 - **PJLink Password** lets you enter a password up to 32 alphanumeric characters long for using the PJLink protocol for projector control.
 - **Remote Password** lets you enter a password up to 8 alphanumeric characters long for accessing the Remote or Basic Control screen on a smartphone or tablet.
 - **Display LAN Info** lets you select how the projector displays network information. You can select an option to display a QR code that lets you quickly connect your iOS or Android devices using the Epson iProjection app.

Note: Use the displayed keyboard to enter the name, passwords, and keyword. Press the arrow buttons on the remote control to highlight characters and press **Enter** to select them. Press **Finish** when you are done.

7. Select the **Wired LAN** menu and press **Enter**.

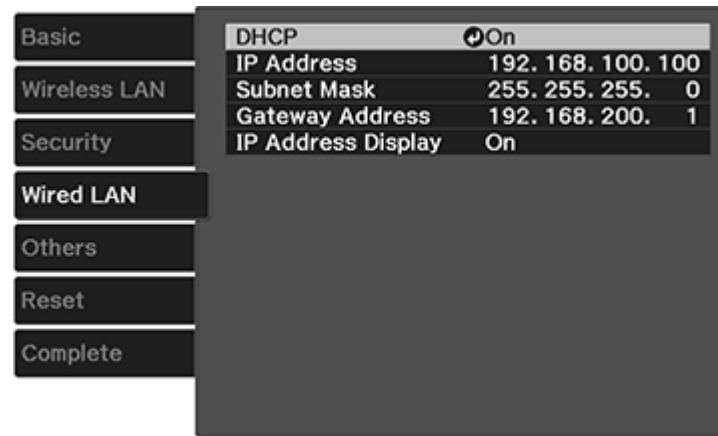

8. Select your IP Settings as necessary:
 - If your network assigns addresses automatically, turn on the **DHCP** setting.
 - If you must set addresses manually, turn off **DHCP** and enter the projector's **IP Address**, **Subnet Mask**, and **Gateway Address** as needed.

Note: To highlight the numbers you want from the displayed keyboard, press the arrow buttons on the remote control. To select a highlighted number, press **Enter**. Press **Finish** when you are done.

9. To prevent display of the IP address on the standby screen, turn off **IP Address Display**.
10. When you finish selecting settings, select **Complete** and follow the on-screen instructions to save your settings and exit the menus.

Parent topic: [Wired Network Projection](#)

Wireless Network Projection

You can project over a wireless network. To do this, you must set up your projector and computer for wireless projection.

Note: The Epson 802.11b/g/n wireless LAN module is not included with your projector and is optional.

To connect wirelessly to your projector, configure the connection using the projector's Network menus.

After connecting and setting up the projector, install the projector software. You may need to install it from a software CD, if included, or download the software and manuals as necessary.

Note: Wireless network connectivity is not recommended for video streaming.

Note: If your projector is connected via a LAN cable to a network that includes a wireless access point, you can connect to the projector wirelessly through the access point using the Epson network software.

[Installing the Wireless LAN Module](#)

[Selecting Wireless Network Settings Manually](#)

[Using a QR Code to Connect a Mobile Device](#)

[Searching for a Wireless Network](#)

[Selecting Wireless Network Settings in Windows](#)

[Selecting Wireless Network Settings on Mac](#)

[Enabling WPA or WPA2 Security](#)

Parent topic: [Using the Projector on a Network](#)

Related references

[Additional Projector Software and Manuals](#)

Installing the Wireless LAN Module

To use the projector over a wireless network, install the Epson 802.11b/g/n wireless LAN module in the projector. Do not install any other type of wireless module.

Note: The wireless LAN module is not included with your projector.

Insert the wireless LAN module into the **USB** port.

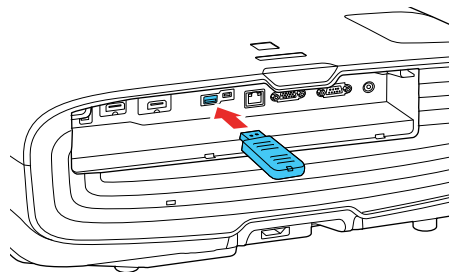

The light on the wireless LAN module turns on when the module is installed and operating. The light flashes when the module is communicating over the network.

Parent topic: [Wireless Network Projection](#)

Selecting Wireless Network Settings Manually

Before you can project from your wireless network, you must select the network settings for the projector using its menu system.

1. Turn on the projector.
2. Press the **Menu** button.
3. Select the **Network** menu and press **Enter**.

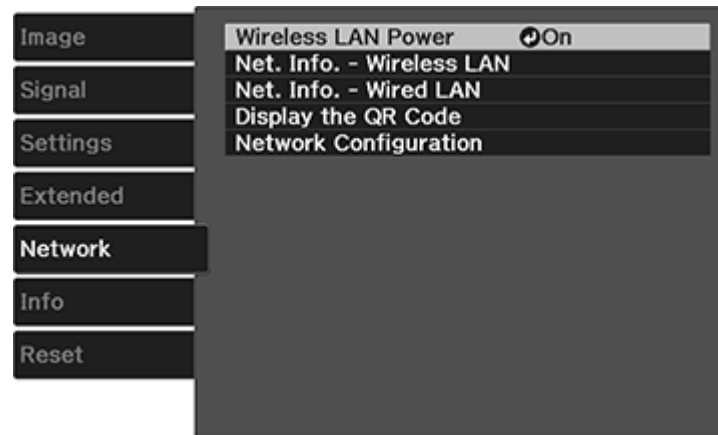

4. Make sure the **Wireless LAN Power** setting is set to **On**.
5. Select **Network Configuration** and press **Enter**.

6. Select the **Basic** menu and press **Enter**.

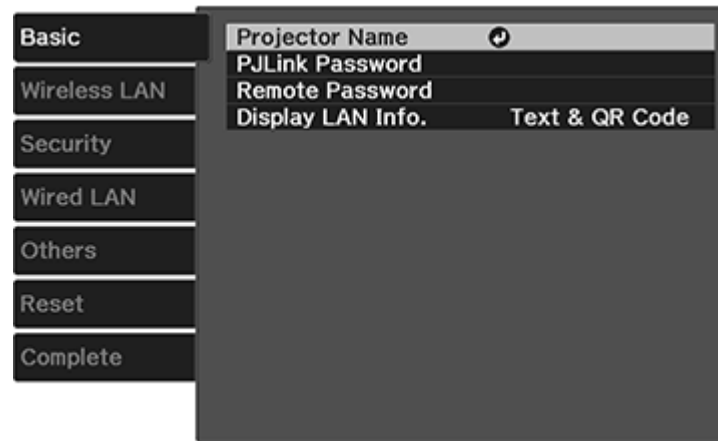

7. Select the following basic options as necessary:

- **Projector Name** lets you enter a name up to 16 alphanumeric characters long to identify the projector over the network.
- **PJLink Password** lets you enter a password up to 32 alphanumeric characters long for using the PJLink protocol for projector control.
- **Remote Password** lets you enter a password up to 8 alphanumeric characters long for accessing the Remote or Basic Control screen on a smartphone or tablet.
- **Display LAN Info** lets you select how the projector displays network information. You can select an option to display a QR code that lets you quickly connect your iOS or Android devices with the Epson iProjection app.

Note: Use the displayed keyboard to enter the name, passwords and keyword. Press the arrow buttons on the remote control to highlight characters and press **Enter** to select them. Press **Finish** when you are done.

8. Select the **Wireless LAN** menu and press **Enter**.

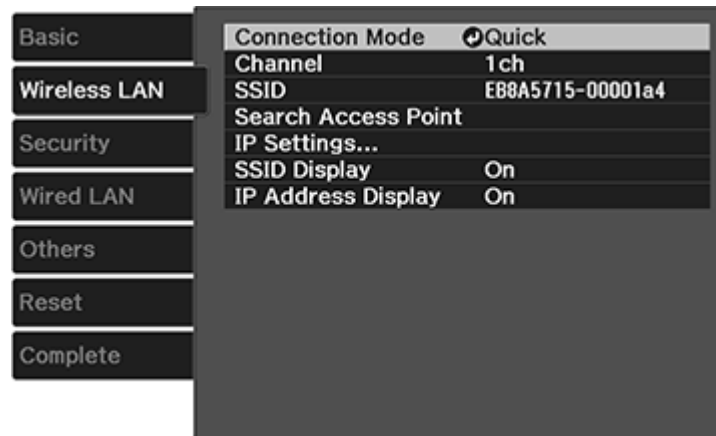

9. Select the settings on the **Wireless LAN** menu as necessary for your network.
10. When you finish selecting settings, select **Complete** and follow the on-screen instructions to save your settings and exit the menus.

After you complete the wireless settings for your projector, you need to select the wireless network on your computer, or iOS or Android device.

[Wireless LAN Menu Settings](#)

[Restricted IP Addresses](#)

Parent topic: [Wireless Network Projection](#)

Wireless LAN Menu Settings

Setting	Options	Description
Connection Mode	Quick Advanced	Selects the type of wireless connection: Quick: lets you quickly connect to local devices without an internet connection Advanced: lets you connect to multiple computers via a wireless network access point (infrastructure mode)
Channel	1ch 6ch 11ch	In Quick connection mode, selects the frequency band (channel) used by the wireless LAN
SSID	Up 32 alphanumeric characters	Sets the SSID (network name) of the wireless LAN system the projector is connecting to
Search Access Point	To Search View	Searches for available wireless network access points in Advanced connection mode
IP Settings	—	Turns on DHCP if your network assigns addresses automatically; set to Off to manually enter the network's IP Address , Subnet Mask , and Gateway Address (see list of restricted IP addresses in link below)
SSID Display	On Off	Selects whether to display the SSID on the network standby screen and the Home screen
IP Address Display	On Off	Selects whether to display the IP address on the network standby screen and the Home screen

Parent topic: [Selecting Wireless Network Settings Manually](#)

Related references

[Restricted IP Addresses](#)

Restricted IP Addresses

When manually entering IP Settings, you cannot use these ranges of IP addresses:

Setting	Restricted IP addresses
IP Address	0.0.0.0 127.x.x.x 224.0.0.0 to 255.255.255.255
Subnet Mask	0.0.0.0 255.255.255.255
Gateway Address	0.0.0.0 127.x.x.x 224.0.0.0 to 255.255.255.255

Parent topic: [Selecting Wireless Network Settings Manually](#)

Using a QR Code to Connect a Mobile Device

After you select the wireless network settings for your projector, you can display a QR code on the screen and use it to connect a mobile device using the Epson iProjection app.

Note: Make sure you have installed the latest version of Epson iProjection on your device. Visit epson.com/iprojection (U.S.) or epson.ca/iprojection (Canada) for more information.

1. Press the **Menu** button.

2. Select the **Network** menu and press **Enter**.

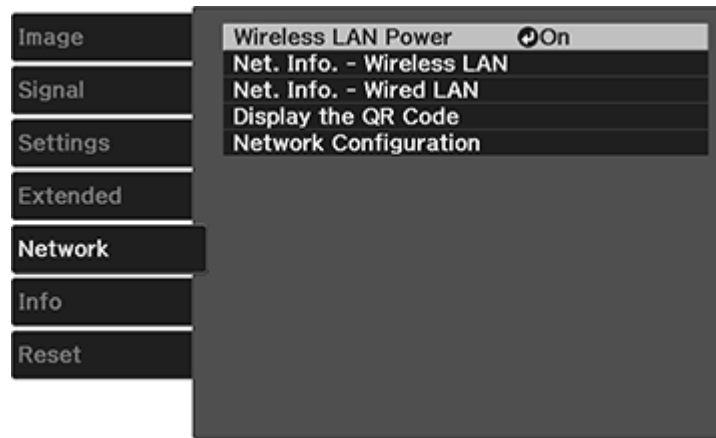

3. Select **Network Configuration** and press **Enter**.
4. Select the **Basic** menu and press **Enter**.

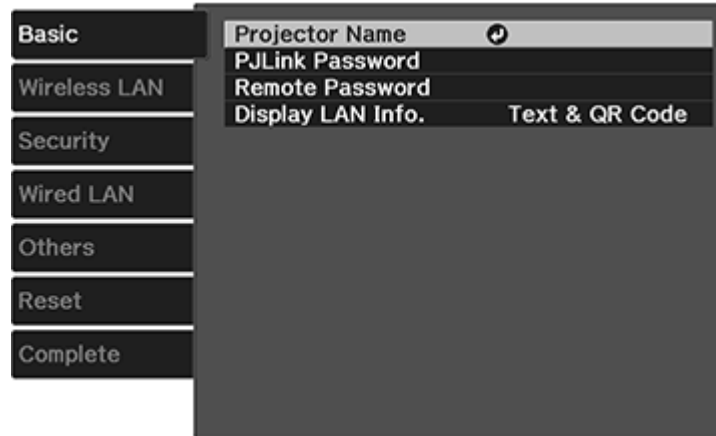

5. Set the **Display LAN Info** setting to **Text & QR Code**.
6. Select **Complete** and follow the on-screen instructions to save your settings and exit the menus.

7. Do one of the following:
 - Press the **LAN** button on the remote control.
 - Select **Display the QR Code** in the projector's Network menu.
 - Press the **Home** button on the remote control and select **Display the QR Code** on the Home screen.

Your projector displays the QR code on the projection surface.

Note: If you do not see the QR code after pressing the **LAN** button, press **Enter** to display it.

8. Start Epson iProjection on your mobile device.
9. Use the QR code reader feature to read the QR code and connect your device to the projector. Visit epson.com/iprojection (U.S.) or epson.ca/iprojection (Canada) for instructions.

Parent topic: [Wireless Network Projection](#)

Searching for a Wireless Network

You can use your projector's site survey function to quickly locate and connect to available wireless networks.

1. Turn on the projector.
2. Press the **Menu** button.
3. Select the **Network** menu and press **Enter**.

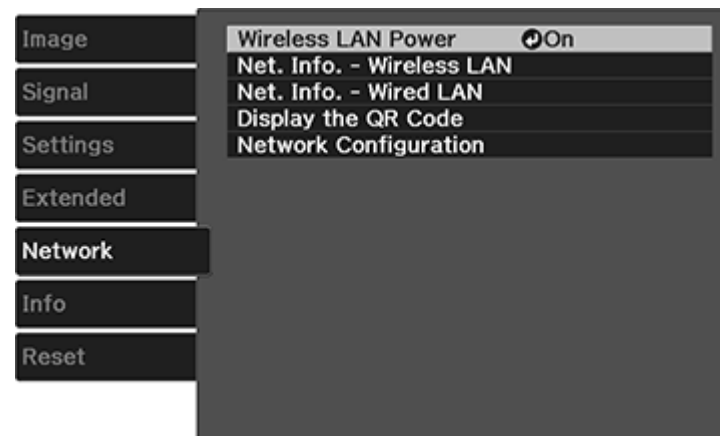

4. Select **Network Configuration** and press **Enter**.
5. Select the **Wireless LAN** menu and press **Enter**.

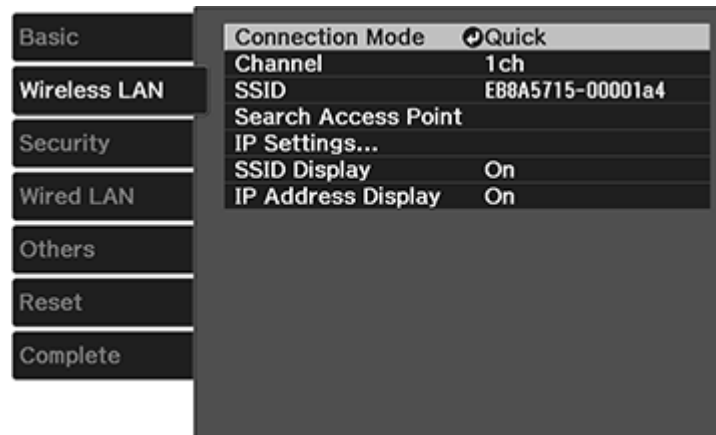

6. Select **Advanced** as the Connection Mode setting and press **Enter**.
7. Select **Search Access Point** and press **Enter**.
8. Select the name of the wireless network you want to connect to and press **Enter**.
9. If the network has security enabled, enter the wireless password.

You see a screen like this:



10. Select the settings on the Security menu as necessary for your network.
11. When you finish selecting settings, select **Complete** and follow the on-screen instructions to save your settings and exit the menus.

Parent topic: [Wireless Network Projection](#)

Selecting Wireless Network Settings in Windows

Before connecting to the projector, select the correct wireless network on your computer.

1. To access your wireless utility software, access the Desktop and double-click the network icon on the Windows taskbar.
2. Do one of the following:
 - If your projector is set up on an existing network (Advanced mode), select the network name (SSID).
 - If your projector is configured for Quick mode, select the projector's SSID.
3. Click **Connect**.

Parent topic: [Wireless Network Projection](#)

Selecting Wireless Network Settings on Mac

Before connecting to the projector, select the correct wireless network on your Mac.

1. Click the AirPort icon on the menu bar at the top of the screen.
2. Make sure AirPort is turned on, then do one of the following:
 - If your projector is set up on an existing network (Advanced mode), select the network name (SSID).
 - If your projector is configured for Quick mode, select the projector's SSID.

Parent topic: [Wireless Network Projection](#)

Enabling WPA or WPA2 Security

Set up the WPA or WPA2 security settings to match your network's settings. Check with your network administrator for guidance on entering the correct information.

1. Turn on the projector.
2. Press the **Menu** button.

3. Select the **Network** menu and press **Enter**.

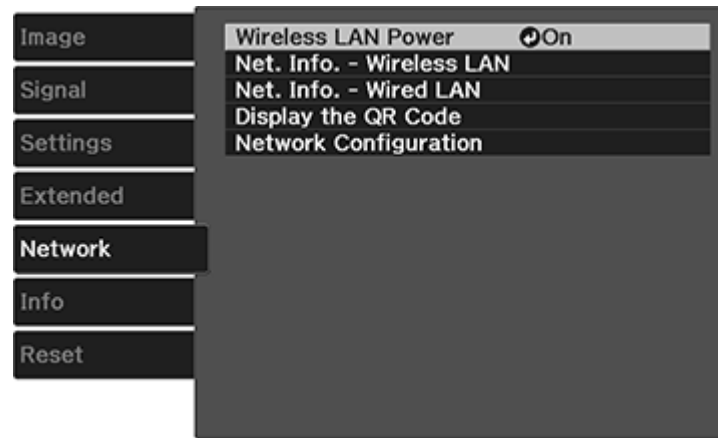

4. Select **Network Configuration** and press **Enter**.
5. Select the **Security** menu and press **Enter**.
6. Select the settings on the Security menu as necessary for your network.
7. When you finish selecting settings, select **Complete** and follow the on-screen instructions to save your settings and exit the menus.

[Wireless Security Menu Settings](#)

Parent topic: [Wireless Network Projection](#)

Wireless Security Menu Settings

Settings on the Security menu let you select the type of security and security settings that match the network you are connecting the projector to.

Setting	Options	Description
Security	No WPA2-PSK WPA/WPA2-PSK	Selects the type of security used on the wireless network

Setting	Options	Description
Passphrase	—	For the selected security, selects the pre-shared passphrase used on the network

Parent topic: [Enabling WPA or WPA2 Security](#)

Selecting External Network Detection Settings

If you are using a compatible network control system, you can select settings that allow your projector to be detected by those systems.

1. Press the **Menu** button.
2. Select the **Network** menu and press **Enter**.
3. Select **Network Configuration** and press **Enter**.
4. Select the **Others** menu and press **Enter**.

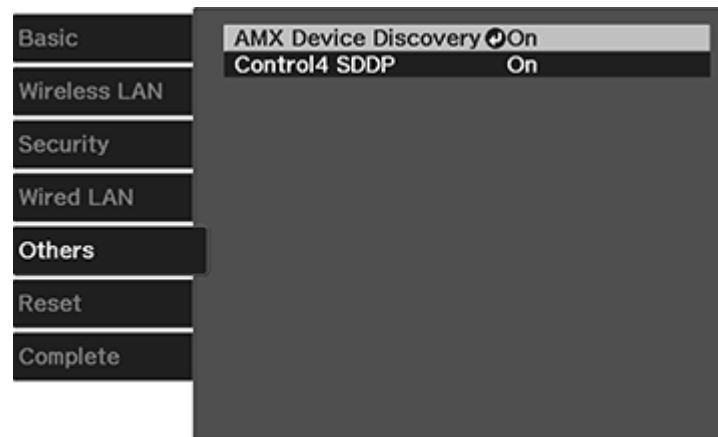

5. If your network environment uses an AMX controller, turn on the **AMX Device Discovery** setting to allow the projector to be detected.
6. If your network environment uses a Control4 or Control4 SDDP controller, turn on the **Control4 SDDP** setting to allow the projector to be detected.
7. When you finish selecting settings, select **Complete** and follow the on-screen instructions to save your settings and exit the menus.

Parent topic: [Using the Projector on a Network](#)

Using Basic Projector Features

Follow the instructions in these sections to use your projector's basic features.

[Turning On the Projector](#)

[Turning Off the Projector](#)

[Viewing 3D Images](#)

[Selecting the Language for the Projector Menus](#)

[Adjusting the Image Height](#)

[Adjusting the Image Position Using Lens Shift](#)

[Image Shape](#)

[Resizing the Image with the Zoom Feature](#)

[Focusing the Image with the Lens Button](#)

[Remote Control Operation](#)

[Selecting an Image Source](#)

[Projection Modes](#)

[Image Aspect Ratio](#)

[Color Mode](#)

Turning On the Projector

Turn on the computer or video equipment you want to use before you turn on the projector so it can display the image source.

1. Connect the power cord to the projector's power inlet.

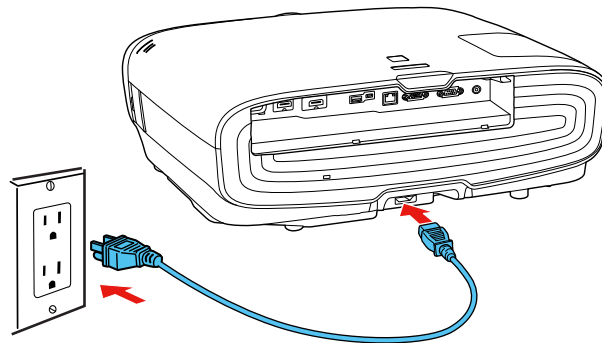

2. Plug the power cord into an electrical outlet.

Note: With **Direct Power On** turned on, the projector turns on as soon as you plug it in.

The projector's power light turns blue. This indicates that the projector is receiving power.

3. Press the power button on the projector or the **On** button on the remote control to turn on the projector.

Warning: Never look into the projector lens when the lamp is on. This can damage your eyes and is especially dangerous for children.

If you do not see a projected image right away, try the following:

- Turn on the connected computer or video device.
- Insert a DVD or other video media and press the play button, if necessary.
- Press the **Source** button on the projector to detect the video source, or press a source button on the remote control.
- If the Home screen is displayed, select the source you want to project.

[Using the Home Screen](#)

Parent topic: [Using Basic Projector Features](#)

Related references

[Projector Setup Settings - Extended Menu](#)

Using the Home Screen

You can select input sources and other frequently used options from the Home screen.

1. To display the Home screen, do one of the following:
 - Press the **Home** button on the remote control.
 - Turn on the projector with the **Home Screen Auto Disp** setting enabled.
 - Turn on the projector when no signal is received from the selected input source.

2. Press the arrow buttons on the remote control or control panel to navigate the screen, and press **Enter** to select an option.

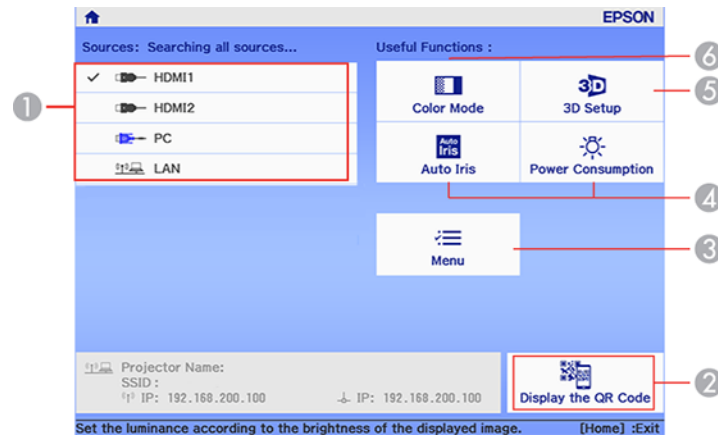

- 1 Select the video source you want to project
- 2 Display the QR code
- 3 Display the projector's menus
- 4 Select customizable menu options
- 5 Select to change the 3D settings
- 6 Select to change the Color Mode

Note: You can select the customizable menu options using the **Custom Function 1** and **Custom Function 2** settings in the Extended menu.

3. Press the **Home** button to hide the Home screen.

Parent topic: [Turning On the Projector](#)

Related references

[Projector Setup Settings - Extended Menu](#)

Turning Off the Projector

Before turning off the projector, shut down any computer connected to it so you can see the computer display during shutdown.

Note: Turn off this product when not in use to prolong the life of the projector. Lamp life will vary depending upon mode selected, environmental conditions, and usage. Brightness decreases over time.

Note: When using the Blank feature, the projector lamp is still on. To turn off the lamp, turn off the projector.

Note: If the **Standby Confirmation** setting is set to **Off** on the **Settings** menu, the projector shuts down immediately when you press the power button on the projector or the **Standby** button on the remote control.

1. Press the power button on the projector or the **Standby** button on the remote control.

The projector displays a shutdown confirmation screen.



2. Press the power button on the projector or the **Standby** button on the remote control again. (To leave it on, press any other button.)

The lamp turns off and the lens shutter closes. The projector's **Status** light flashes and then turns off.

Note: If you unplug the projector before the **Status** light stops flashing and need to turn the projector back on, wait until the lamp has cooled down (about 10 minutes), plug the power cord back in, and turn the projector on again. You cannot operate the projector until it finishes cooling down.

3. To transport or store the projector, make sure the Status light is off, then unplug the power cord.

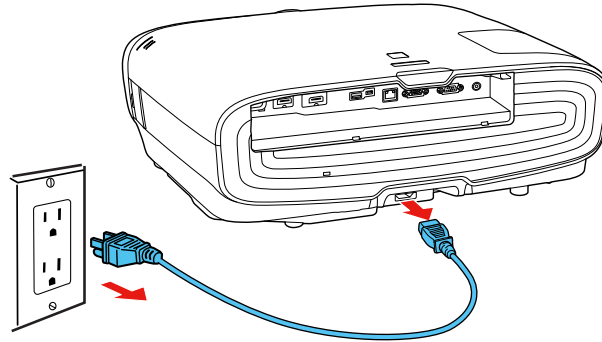

Caution: To avoid damaging the projector or lamp, never unplug the power cord when the Status light is on or flashing.

Parent topic: [Using Basic Projector Features](#)

Related references

[Projector Feature Settings - Settings Menu](#)

Related tasks

[Shutting Off the Picture Temporarily](#)

[Transporting the Projector](#)

Viewing 3D Images

You can view 3D images using your projector. Viewing 3D images requires a 3D-compatible video device, a compatible HDMI cable, and a pair of Epson RF 3D glasses (not included with your projector). You can also convert 2D images to 3D using the **2D-to-3D Conversion** setting in your projector's **Signal > 3D Setup** menu.

You can purchase Epson RF 3D glasses from an Epson authorized reseller. To find the nearest reseller, call 800-GO-EPSON (800-463-7766) in the U.S. or 800-807-7766 in Canada. Or you can purchase online at epsonstore.com (U.S. sales) or epsonstore.ca (Canadian sales).

Note: Make sure the **3D Display** setting on the **Signal** menu is set to **Auto** or **3D**.

1. Connect a 3D-compatible video device to the projector using a compatible HDMI cable.

2. Turn on the video device, then turn on the projector.
3. Begin playback from the video device.

Note: Make sure you set the video device to play content in 3D mode.

4. Slide the power switch on the 3D glasses to the **On** position.

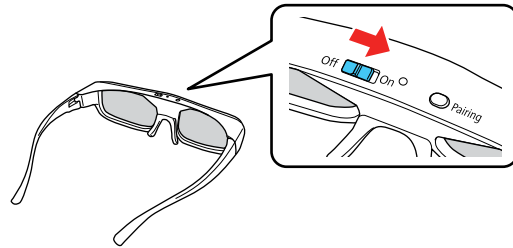

5. Put on the 3D glasses and view the projected image. If you do not see a 3D image, pair the glasses with the projector.

Note: If you change the video source or you are not within range of your projector, the glasses enter standby mode and the status light flashes green. Slide the power switch on the glasses to the **Off** position and then back to the **On** position to resume 3D viewing.

[Pairing the 3D Glasses with the Projector](#)

[Charging the 3D Glasses](#)

[3D Viewing Range](#)

Parent topic: [Using Basic Projector Features](#)

Related references

[Input Signal Settings - Signal Menu](#)

Related tasks

[Connecting to an HDMI Video Source](#)

Pairing the 3D Glasses with the Projector

Pair the glasses with the projector to establish communication between them for 3D viewing.

1. Turn on the projector.

2. Set the image source on the projector to HDMI.
3. Project a 3D image.
4. Slide the power switch on the 3D glasses to the **On** position.

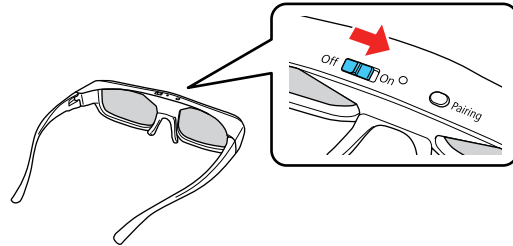

5. Move the glasses within 10 feet (3 m) of the projector and hold down the **Pairing** button for at least three seconds.

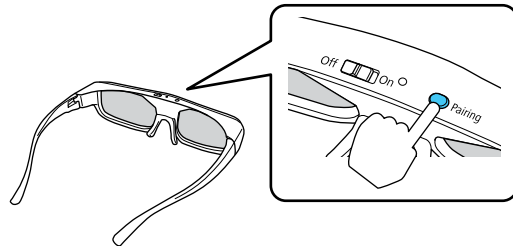

The status light on the glasses flashes green and red. If pairing is successful, the light turns green for 10 seconds and then turns off.

Parent topic: [Viewing 3D Images](#)

Charging the 3D Glasses

When the status light on the glasses flashes red to indicate a low battery, it is time to charge the glasses.

1. Connect the smaller end of the charging cable to the port on the bridge of the glasses.

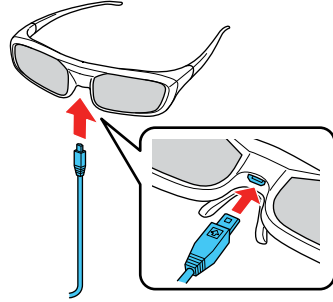

Note: Make sure you connect the cable in the correct orientation or you may damage the glasses or cable.

2. Do one of the following:
 - Plug the other end of the charging cable into a powered USB port on a computer or other device.
 - Plug the other end of the charging cable into a USB-to-AC adapter with the following specifications:
 - Input: 100-240V, ~0.15A, 50-60Hz
 - Output: 5V=1A

The glasses are fully charged when the status light on the glasses stays green.

Parent topic: [Viewing 3D Images](#)

3D Viewing Range

When you view 3D images, make sure you are positioned within the viewing range shown here.

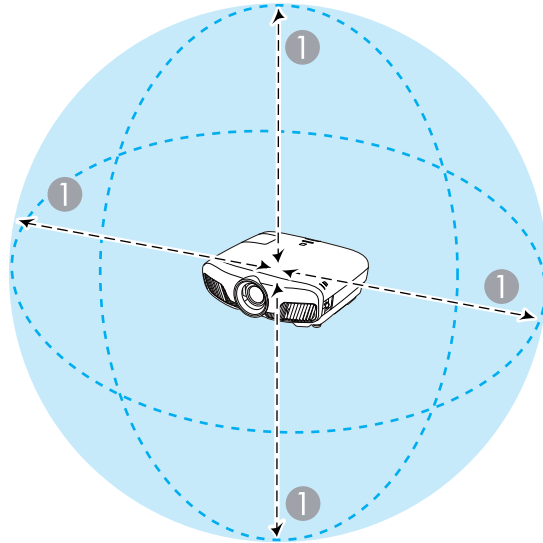

1 32 ft (10 m)

Parent topic: [Viewing 3D Images](#)

Selecting the Language for the Projector Menus

If you want to view the projector's menus and messages in another language, you can change the Language setting.

1. Turn on the projector.
2. Press the **Menu** button.

3. Select the **Extended** menu and press **Enter**.

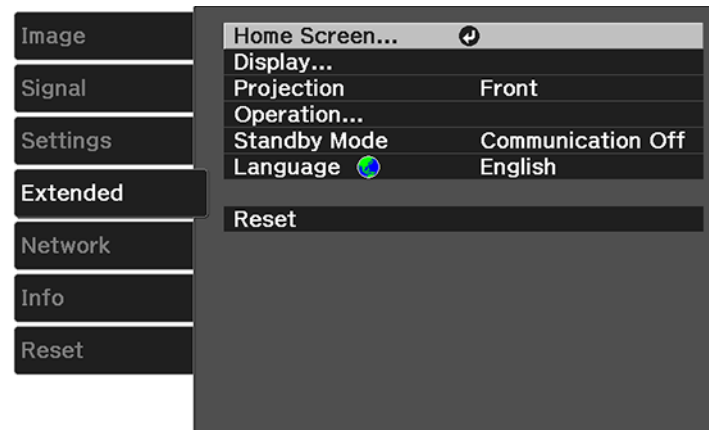

4. Select the **Language** setting and press **Enter**.
5. Select the language you want to use and press **Enter**.
6. Press **Menu** or **Esc** to exit the menus.

Parent topic: [Using Basic Projector Features](#)

Adjusting the Image Height

If you are projecting from a table or other flat surface, and the image is too high or low, you can adjust the image height using the projector's adjustable feet.

1. Turn on the projector and display an image.
2. If the image is tilted, rotate the front feet to adjust their height.

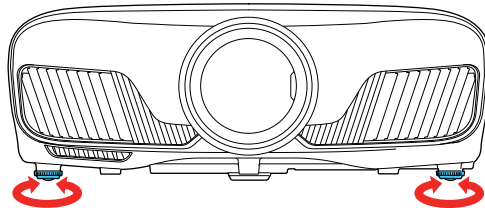

3. To adjust the position of the projected image further, press the **Lens** button on the remote control or projector until **Adjust Lens Shift** appears on the screen.

If the projected image is unevenly rectangular, you need to adjust the image shape.

Parent topic: [Using Basic Projector Features](#)

Related concepts

[Image Shape](#)

Adjusting the Image Position Using Lens Shift

If you cannot install the projector directly in front of the screen, you can adjust the position of the projected image using the lens shift feature.

1. Turn on the projector and display an image.
2. Press the **Lens** button on the control panel or remote control.

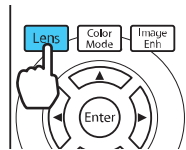

3. Press the **Lens** button repeatedly until **Adjust Lens Shift** appears on the screen.

4. Press the arrow buttons on the remote control or the control panel to adjust the position of the projected image as necessary.

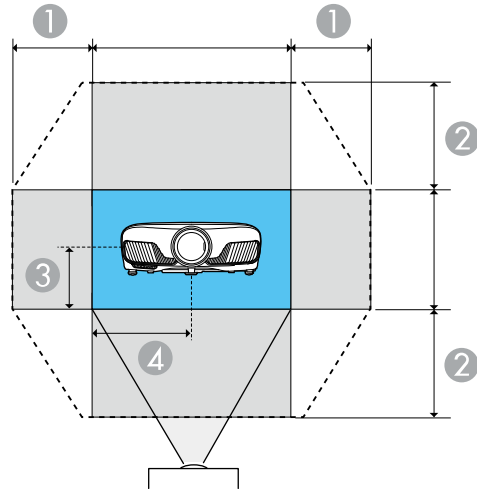

- 1 Maximum horizontal range ($H \times 47\%$)
- 2 Maximum vertical range ($V \times 96\%$)
- 3 $1/2$ the vertical height of the image
- 4 $1/2$ the horizontal width of the image

Note: You cannot move the image to both the horizontal and vertical maximum values.

5. When you are finished, press the **Esc** button on the control panel or remote control.

Note: When adjusting the image height, position the image lower than where you want it to be and then move it up. This will help prevent the image from moving down after adjustment. The image is clearest when the lens is at the home position. To move the lens to the home position, press the arrow buttons on the remote control or the control panel to move the image towards the center of the screen until it stops at the home position.

Parent topic: [Using Basic Projector Features](#)

Image Shape

You can project an evenly rectangular image by placing the projector directly in front of the center of the screen and keeping it level. If you place the projector at an angle to the screen, or tilted up or down, or off to the side, you may need to correct the image shape for the best display quality.

[Correcting Image Shape With the Keystone Buttons](#)

Parent topic: [Using Basic Projector Features](#)

Correcting Image Shape With the Keystone Buttons

You can use the projector's keystone correction buttons to correct the shape of an image that is unevenly rectangular on the sides.

1. Turn on the projector and display an image.

Note: You can display a pattern to aid in adjusting the projected image using the **Pattern** button on the remote control.

2. Press a keystone button on the projector's control panel.

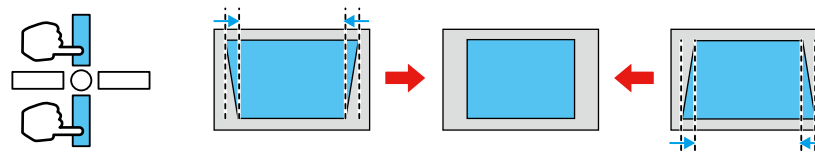

After correction, your image is slightly smaller.

Note: If the projector is installed out of reach, you can also correct the image shape using the Keystone settings in the projector menus.

Parent topic: [Image Shape](#)

Related references

[Projector Feature Settings - Settings Menu](#)

Resizing the Image with the Zoom Feature

You can adjust the size of the projected image using the zoom feature.

1. Turn on the projector and display an image.
2. Press the **Lens** button on the control panel or remote control.

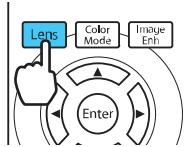

3. Press the **Lens** button repeatedly until **Adjust Zoom** is displayed on the screen.
4. Press and hold the left or right arrow button on the control panel or remote control to resize the image.
5. Press the **Esc** button on the control panel or remote control when finished.

Parent topic: [Using Basic Projector Features](#)

Focusing the Image with the Lens Button

You can adjust the sharpness of the projected image using the focus feature.

1. Turn on the projector and display an image.
2. Press the **Lens** button on the control panel or remote control.

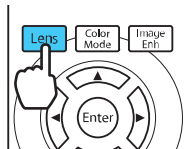

3. Press the **Lens** button repeatedly until **Adjust Focus** is displayed on the screen.
4. Press and hold the left or right arrow button on the control panel or remote control to focus the image.
5. Press the **Esc** button on the control panel or remote control when finished.

Parent topic: [Using Basic Projector Features](#)

Remote Control Operation

The remote control lets you control the projector from almost anywhere in the room. You can point it at the screen, or the front or back of the projector.

Make sure that you aim the remote control at the projector's receivers within the distance and angles listed here.

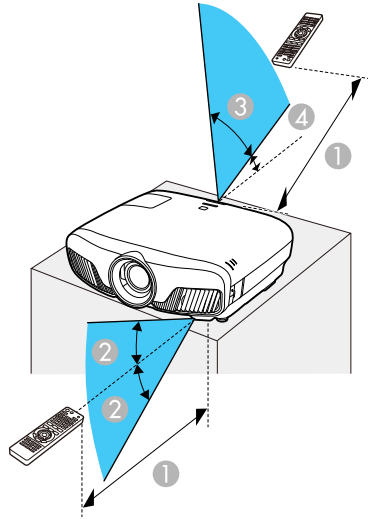

1 32 feet (10 m)

2 $\pm 30^\circ$

3 60°

4 10°

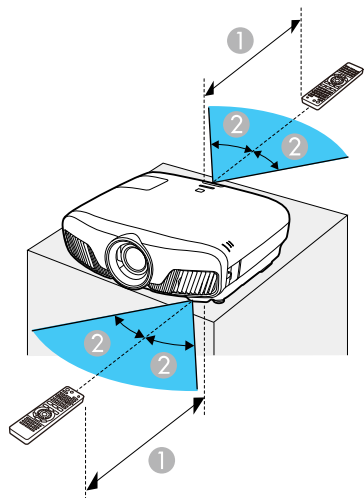

1 32 feet (10 m)

2 ± 30°

Note: Avoid using the remote control in conditions with bright fluorescent lights or in direct sunlight, or the projector may not respond to commands. If you will not use the remote control for a long time, remove the batteries.

Parent topic: [Using Basic Projector Features](#)

Related tasks

[Using the Home Screen](#)

Selecting an Image Source

If you connected multiple image sources to the projector, such as a computer and DVD player, you may want to switch from one image source to the other.

1. Make sure the connected image source you want to use is turned on.
2. For video image sources, insert a DVD or other video media and press its play button, if necessary.

3. Do one of the following:

- Press the **Source** button on the projector until you see the image from the source you want.

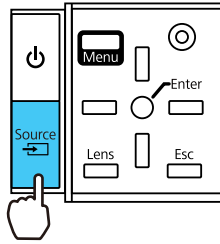

- Press the button for the source you want on the remote control. If there is more than one port for that source, press the button again to cycle through the sources.

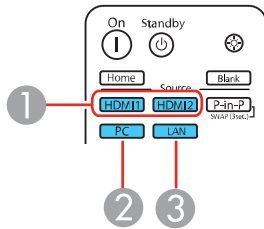

- 1 HDMI port sources
- 2 Computer port source (VGA)
- 3 Network source

- Press the **Home** button on the remote control and select your image source.

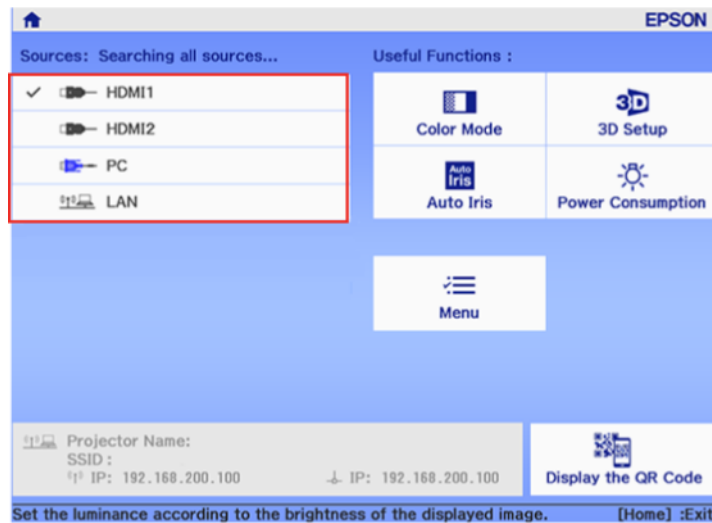

Parent topic: [Using Basic Projector Features](#)

Projection Modes

Depending on how you positioned the projector, you may need to change the projection mode so your images project correctly.

- **Front** (default setting) lets you project from a table in front of the screen.
- **Front/Ceiling** flips the image over top-to-bottom to project upside-down from a ceiling or wall mount.
- **Rear** flips the image horizontally to project from behind a translucent screen.
- **Rear/Ceiling** flips the image over top-to-bottom and horizontally to project from the ceiling and behind a translucent screen.

[Changing the Projection Mode Using the Menus](#)

Parent topic: [Using Basic Projector Features](#)

Changing the Projection Mode Using the Menus

You can change the projection mode to flip the image over top-to-bottom and/or left-to-right using the projector menus.

1. Turn on the projector and display an image.
2. Press the **Menu** button.
3. Select the **Extended** menu and press **Enter**.

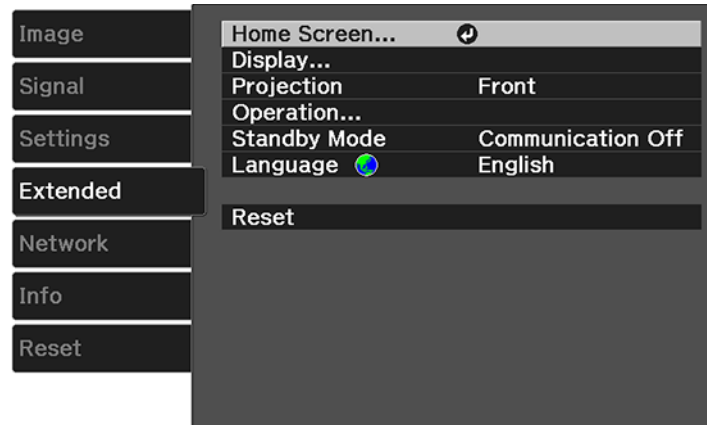

4. Select the **Projection** setting and press **Enter**.
5. Select a projection mode and press **Enter**.
6. Press **Menu** or **Esc** to exit the menus.

Parent topic: [Projection Modes](#)

Related concepts

[Projector Placement](#)

Image Aspect Ratio

The projector can display images in different width-to-height ratios called aspect ratios. Normally the input signal from your video source determines the image's aspect ratio. However, for certain images you can change the aspect ratio to fit your screen by pressing a button on the remote control.

If you always want to use a particular aspect ratio for a certain video input source, you can select it using the projector's menus.

[Changing the Image Aspect Ratio](#)

[Available Image Aspect Ratios](#)

Parent topic: [Using Basic Projector Features](#)

Changing the Image Aspect Ratio

You can change the aspect ratio of the displayed image to resize it.

Note: For HDMI sources, the input signal determines the image's aspect ratio.

1. Turn on the projector and switch to the image source you want to use.
2. Press the **Aspect** button on the remote control.

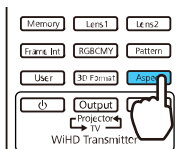

A list of the available aspect ratios appears.

3. To cycle through the available aspect ratios for your input signal, press the up or down arrow button.
4. Press **Enter** to select the aspect ratio.

Parent topic: [Image Aspect Ratio](#)

Available Image Aspect Ratios

You can select the following image aspect ratios, depending on the input signal from your image source.

Note: When the projector is in 3D mode, the aspect ratio is automatically set to **Normal**.

Note: Black bands and cropped images may project in certain aspect ratios, depending on the aspect ratio and resolution of your input signal.

Aspect ratio setting	Description
Auto	Automatically sets the aspect ratio according to the input signal.
Normal	Displays images using the full projection area and maintains the aspect ratio of the image.
Zoom	Displays images using the full width of the projection area and maintains the aspect ratio of the image.

Aspect ratio setting	Description
Full	Displays images using the full width of the projection area, but does not maintain the aspect ratio.

Note: When projecting a 4K signal, you can select only **Normal** as the aspect ratio setting.

Parent topic: [Image Aspect Ratio](#)

Color Mode

The projector offers different Color Modes to provide optimum brightness, contrast, and color for a variety of viewing environments and image types. You can select a mode designed to match your image and environment, or experiment with the available modes.

If you always want to use a particular color mode for a certain video input source, you can select it using the projector menus.

[Changing the Color Mode](#)

[Available Color Modes](#)

[Turning On Auto Iris](#)

Parent topic: [Using Basic Projector Features](#)

Changing the Color Mode

You can change the projector's Color Mode using the remote control to optimize the image for your viewing environment.

1. Turn on the projector and switch to the image source you want to use.
2. If you are projecting from a DVD player or other video source, insert a disc or other video media and press the play button, if necessary.
3. Press the **Color Mode** button on the remote control to change the Color Mode.

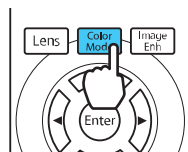

A list of available Color Modes appears.

4. To cycle through all the available Color Modes for your input signal, press the up or down arrow button.
5. Press **Enter** to select a Color Mode.

Parent topic: [Color Mode](#)

Available Color Modes

You can set the projector to use these Color Modes, depending on the input source you are using:

2D Images

Color Mode	Description
Dynamic	Best for projecting in a bright room
Natural	Best for projecting in a dark room
Bright Cinema	Best for projecting in a room with closed curtains
Cinema	Best for projecting color movies in a dark room
B&W Cinema	Best for projecting black and white movies in a dark room
Digital Cinema	Projects using the same color spectrum as digital movie theaters

3D Images

Color Mode	Description
3D Dynamic	Best for projecting in a bright room
3D Cinema	Best for projecting movies in a dark room

Parent topic: [Color Mode](#)

Turning On Auto Iris

In certain color modes, you can turn on the Auto Iris setting to automatically optimize the image based on the brightness of the content you project.

1. Turn on the projector and switch to the image source you want to use.
2. Press the **Menu** button.

3. Select the **Image** menu and press **Enter**.

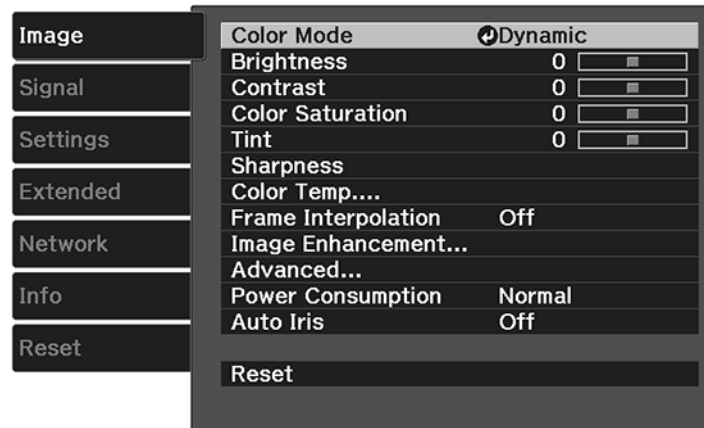

4. Select the **Auto Iris** setting and choose one of the following:
 - **High Speed** to adjust brightness as soon as the scene changes.
 - **Normal** for standard brightness adjustment.

Note: You can set **Auto Iris** for each Color Mode that supports the feature.

5. Press **Menu** or **Esc** to exit the menus.

Parent topic: [Color Mode](#)

Adjusting Projector Features

Follow the instructions in these sections to use your projector's feature adjustments.

[Shutting Off the Picture Temporarily](#)

[Using Picture in Picture](#)

[Projector Security Features](#)

[Using Advanced Image Adjustment Features](#)

[Saving Settings to Memory and Using Saved Settings](#)

[Saving the Lens Position and Using Saved Lens Positions](#)

Shutting Off the Picture Temporarily

You can temporarily turn off the projected picture if you want to redirect your audience's attention during a presentation. Any video action continues to run, however, so you cannot resume projection at the point that you stopped it.

1. Press the **Blank** button on the remote control to temporarily stop projection.

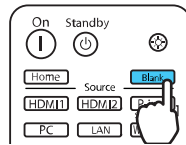

2. To turn the picture back on, press the **Blank** button again.

Parent topic: [Adjusting Projector Features](#)

Using Picture in Picture

You can use Picture in Picture mode to view two image sources simultaneously.

Note: You can display only HDMI video sources when using Picture in Picture mode. You cannot use Picture in Picture while projecting 3D or 4K images.

1. Turn on the projector and switch to the HDMI image source you want to use.

2. Press the **P-in-P** button on the remote control.

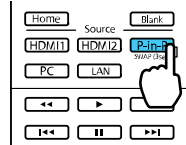

The second HDMI video source appears as a sub-screen in the corner of the image.

Note: Press the **Menu** button on the remote control to adjust picture-in-picture options.

3. To swap the main screen and sub-screen video sources, press and hold the **P-in-P** button for at least three seconds.
4. Press the **P-in-P** button again to exit.

[Available Picture in Picture Options](#)

Parent topic: [Adjusting Projector Features](#)

Available Picture in Picture Options

You can adjust the following options by pressing the **Menu** button on the remote control while using Picture in Picture:

Setting	Description
Subscreen Size	Adjusts the size of the sub-screen
Subscreen Position	Adjusts the location of the sub-screen
Swap Main/Sub	Switches the video source displayed on the main screen with the source displayed on the sub-screen
Exit Picture in Picture	Exits picture-in-picture mode

Parent topic: [Using Picture in Picture](#)

Projector Security Features

You can secure your projector to deter theft or prevent unintended use by setting up the following security features:

- Lens lock to prevent changing the zoom, focus, or lens shift settings.
- Button lock security to block operation of the projector using the buttons on the control panel.
- Security cabling to physically cable the projector in place.

[Locking the Projector's Lens Settings and Buttons](#)

[Installing a Security Cable](#)

Parent topic: [Adjusting Projector Features](#)

Locking the Projector's Lens Settings and Buttons

You can lock the buttons on the projector's control panel to prevent anyone from using the projector. You can also lock the zoom, focus, and lens shift settings to prevent them from being adjusted.

Note: You can use the remote control to control the projector when the control panel buttons are locked.

1. Press the **Menu** button.
2. Select the **Settings** menu and press **Enter**.

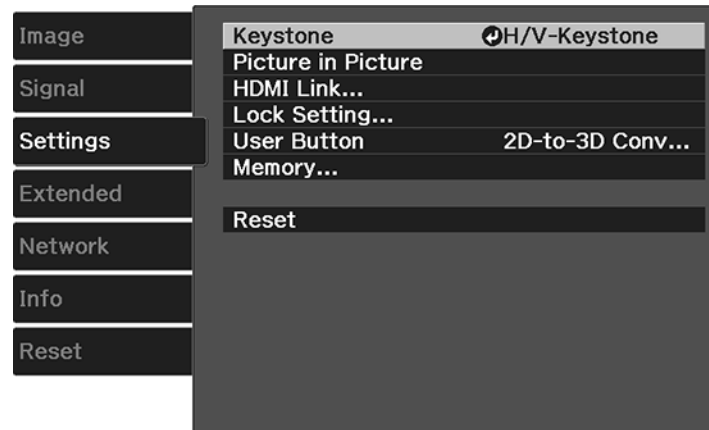

3. Select the **Lock Setting** setting and press **Enter**.

4. Select one of these lock types and press **Enter**:
 - To lock the zoom, focus, and lens shift settings, select **Lens Lock**.
 - To lock the projector's power button, select **Child Lock**. To turn the projector on, you must press the power button for longer than three seconds.

Note: **Child Lock** does not prevent the projector from turning on when the power cord is connected if the **Direct Power On Setting** is set to **On**.

- To lock all buttons, select **Control Panel Lock > Full Lock**.
- To lock all buttons except the power button, select **Control Panel Lock > Partial Lock**.

Note: The  lock icon is displayed on the screen if any control panel buttons are pressed while this setting is enabled.

You see a confirmation prompt.

5. Select **Yes** and press **Enter**.
6. Restart the projector for the lock settings to take effect.

[Unlocking the Projector's Buttons](#)

Parent topic: [Projector Security Features](#)

Unlocking the Projector's Buttons

If the projector's buttons have been locked, hold the **Enter** button on the projector's control panel for seven seconds to unlock them.

Parent topic: [Locking the Projector's Lens Settings and Buttons](#)

Related references

[Projector Feature Settings - Settings Menu](#)

Installing a Security Cable

You can use the security slot on the back of the projector to attach a Kensington lock. See your local computer or electronics dealer for purchase information.

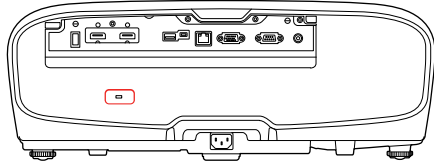

Parent topic: [Projector Security Features](#)

Using Advanced Image Adjustment Features

Follow the instructions in these sections to use your projector's advanced image adjustments.

Note: Not all adjustments may be available depending on the projection mode and input signal.

[Using Frame Interpolation](#)

[Using 4K Enhancement](#)

[Creating Image Presets](#)

[Using MPEG Noise Reduction](#)

[Adjusting Scaled Resolution Images \(Super-resolution\)](#)

[Adjusting Detail Enhancement](#)

[Image Adjustment Restrictions](#)

[Adjusting the Color Convergence \(Panel Alignment\)](#)

[Adjusting the Color Tone \(Color Uniformity\)](#)

Parent topic: [Adjusting Projector Features](#)

Related references

[Image Adjustment Restrictions](#)

Using Frame Interpolation

You can use the projector's Frame Interpolation feature to smooth fast-moving video by comparing consecutive image frames and inserting an intermediate image frame between them.

Note: This feature may not be available depending on the projection mode and input signal.

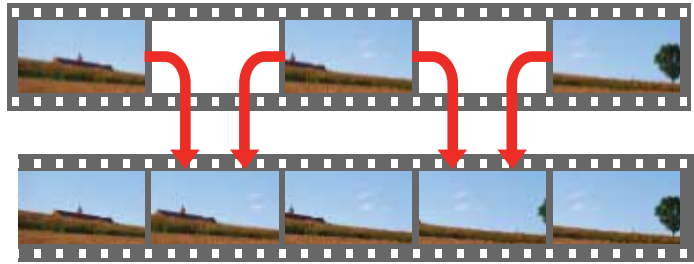

1. Press the **Frame Int** button.

You see a screen like this:

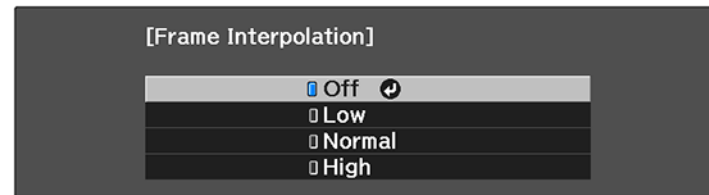

2. Select the level of interpolation and press **Enter**.
3. When you are finished, press the **Frame** button.

Note: If your resulting images contain noise, turn off the **Frame Interpolation** setting.

Parent topic: [Using Advanced Image Adjustment Features](#)

Related references

[Image Adjustment Restrictions](#)

Using 4K Enhancement

Using the projector's 4K Enhancement Technology, you can receive 4K (3840 × 2160 pixel) signals and project ultra high-definition images. This technology shifts each pixel diagonally by 0.5 pixel to double the image resolution.

Note: This feature may not be available depending on the projection mode and input signal.

1. Press the **Menu** button on the remote.

You see a screen like this:

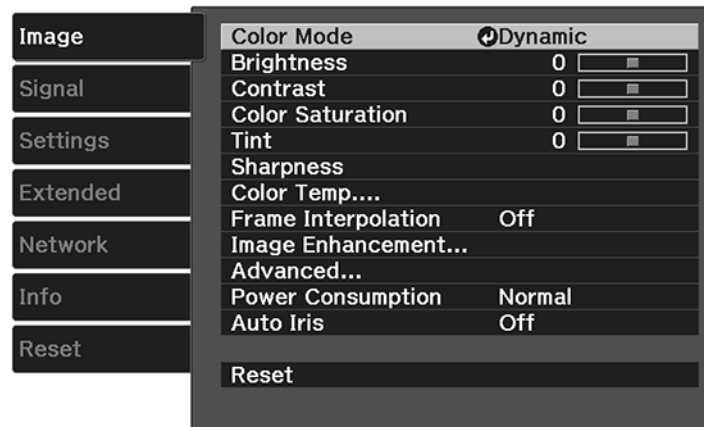

2. Select the **Image Enhancement** setting and press **Enter**.

You see a screen like this:

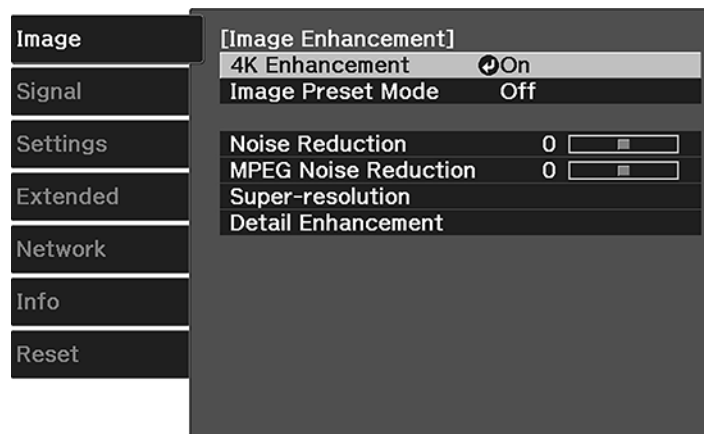

3. Select the **4K Enhancement** setting and press **Enter**.

4. Select one of the following options and press **Enter**:
 - **Off** to disable 4K enhancement
 - **On** to enable 4K enhancement
5. Press **Menu** to exit the menus.

Parent topic: [Using Advanced Image Adjustment Features](#)

Related references

[Image Adjustment Restrictions](#)

Creating Image Presets

You can quickly optimize your projected image by selecting image adjustment settings and saving them as a preset you can reuse later.

To quickly switch between image presets, press the **Image Enh** button on the remote, select an image preset and press **Enter**.

You can save the following settings in a preset:

- Noise Reduction
- MPEG Noise Reduction
- Super-resolution
- Detail Enhancement

1. Press the **Menu** button.

You see a screen like this:

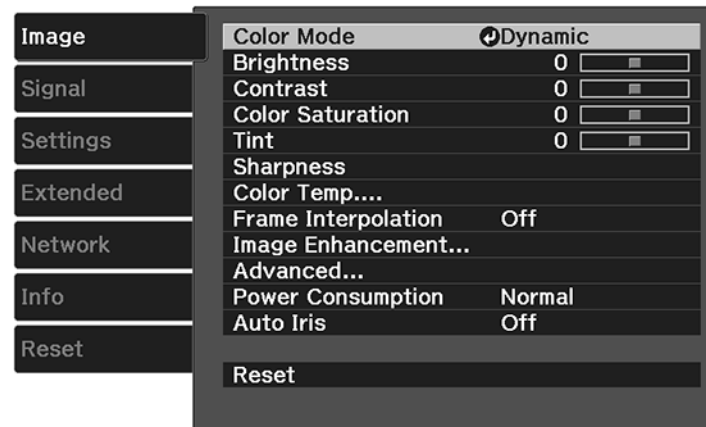

2. Select the **Image Enhancement** setting and press **Enter**.
3. Select the **Image Preset Mode** setting and press **Enter**.

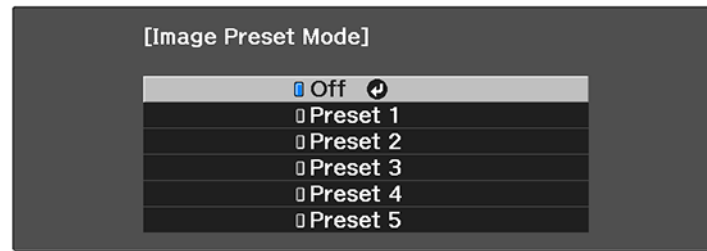

4. Select one of the presets and press **Enter**.

Note: If you select a previously used preset, your new adjustments overwrite the old ones.

5. Press **Esc** to return to the Image Enhancement menu.
6. Fine-tune the following settings:
 - Noise Reduction
 - MPEG Noise Reduction
 - Super-resolution
 - Detail Enhancement
7. Press **Menu** or **Esc** to exit the menus.

The currently selected **Image Preset Mode** will be updated with the current settings.

Parent topic: [Using Advanced Image Adjustment Features](#)

Using MPEG Noise Reduction

If you are projecting MPEG movies, you can reduce dots and block noise by adjusting the **MPEG Noise Reduction** setting.

Note: This feature may not be available depending on the projection mode and input signal.

1. Press the **Menu** button.

You see a screen like this:

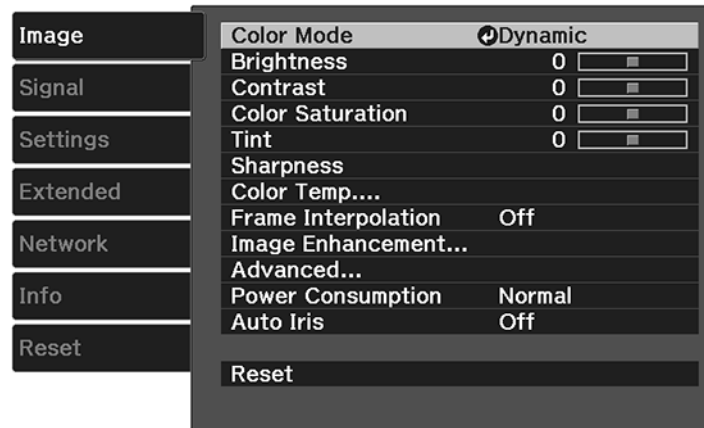

2. Select the **Image Enhancement** setting and press **Enter**.
3. Select the **MPEG Noise Reduction** setting and press **Enter**.
4. Select the level of noise reduction and press **Enter**.
5. Press **Menu** or **Esc** to exit the menus.

Parent topic: [Using Advanced Image Adjustment Features](#)

Related references

[Image Adjustment Restrictions](#)

Adjusting Scaled Resolution Images (Super-resolution)

You can sharpen blurry, low-resolution images that had their resolution scaled up for projection using the **Super-resolution** setting.

Note: This feature may not be available depending on the projection mode and input signal.

1. Turn on the projector and switch to the image source you want to use.
2. Press the **Menu** button.

You see a screen like this:

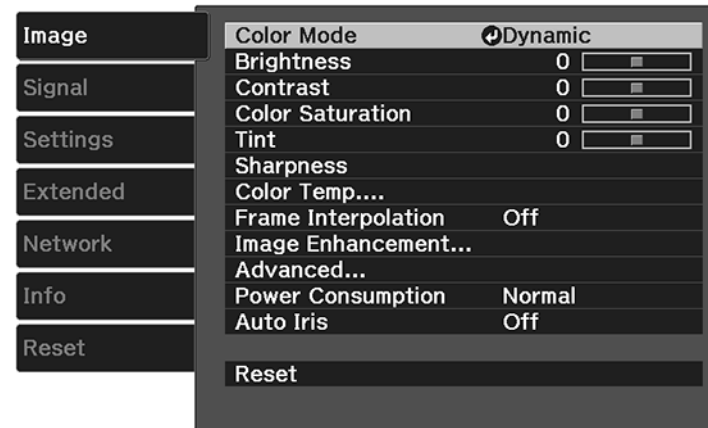

3. Select the **Image Enhancement** setting and press **Enter**.
4. Select the **Super-resolution** setting and press **Enter**.
5. Adjust each of the following options as necessary:
 - **Fine Line Adjust** to enhance fine details such as hair and fabric patterns
 - **Soft Focus Detail** to enhance the outline, background, and main parts of an image

Note: Higher values increase the intensity of the effect.

6. Press **Menu** or **Esc** to exit the menus.

Parent topic: [Using Advanced Image Adjustment Features](#)

Related references

[Image Adjustment Restrictions](#)

Adjusting Detail Enhancement

You can enhance the contrast in detailed areas of an image to create a more textured look.

Note: This feature may not be available depending on the projection mode and input signal.

1. Turn on the projector and switch to the image source you want to use.

2. Press the **Menu** button.

You see a screen like this:

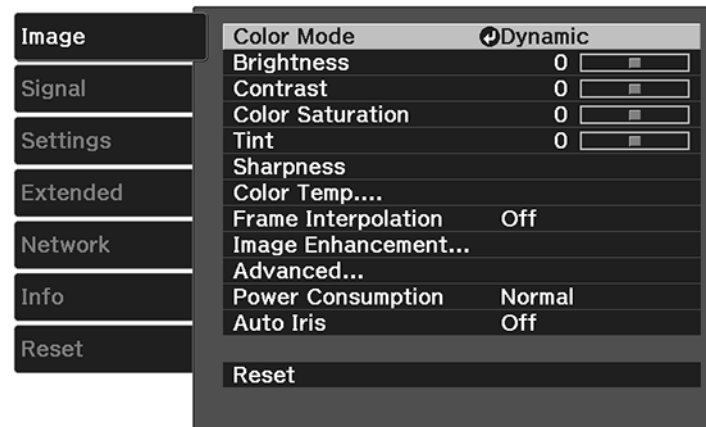

3. Select the **Image Enhancement** setting and press **Enter**.
4. Select the **Detail Enhancement** setting and press **Enter**.
5. Adjust each of the following options as necessary:
 - **Strength** to adjust the image contrast
 - **Range** to adjust the enhanced area of the image

Note: Higher values increase the intensity of the effect.

6. Press **Menu** or **Esc** to exit the menus.

Parent topic: [Using Advanced Image Adjustment Features](#)

Related references

[Image Adjustment Restrictions](#)

Image Adjustment Restrictions

Some advanced adjustment settings cannot be used with certain projection modes or input signals.

	Fine mode (Image Processing)		Fast mode (Image Processing)		2D-to-3D 3D	4K input
Input type	2K		2K		2K 2D or 2K 3D	4K
Projection Mode	2K	4K Enh.	2K	4K Enh.	2K 2D or 2K 3D	4K Enh.
Frame Interpolation	Yes	Yes ^{*1}	—	—	Yes ^{*1}	—
Image Enhancement - 4K Preset	—	Yes	—	Yes	—	Yes
	Noise Reduction	—	Yes	—	—	—
	MPEG Noise Reduction	—	Yes	—	—	—
	Super-resolution/Detail Enhancement	—	Yes	—	Yes	Yes
Image Enhancement - 2K Preset	Yes	—	Yes	—	Yes	—
	Noise Reduction	Yes	—	—	Yes	—
	MPEG Noise Reduction	Yes	—	—	Yes	—
	Super-resolution/Detail Enhancement	Yes	—	Yes	—	Yes

^{*1} Frame Interpolation can only be used with 3D or 4K Enhancement if the signal is 1080p @ 24 Hz.

The following restrictions apply when using image enhancements:

- Fast mode (Image Processing) is not available when displaying a 4K picture.
- Picture in Picture and Fast mode (Image Processing) cannot be used with 3D or 4K projection.
- 2D-to-3D Conversion and 3D projection cannot be used with 4K projection.

Parent topic: [Using Advanced Image Adjustment Features](#)

Adjusting the Color Convergence (Panel Alignment)

You can use the Panel Alignment feature to manually adjust the color convergence (the alignment of the red, green and blue colors) in the projected image.

Note: Allow your projector to warm up for at least 10 to 15 minutes and make sure the image is in focus before you use the Panel Alignment feature. For best results, project an image sized at least 60 inches (152 cm) diagonally in a dark room and on a projection surface that is not colored or textured.

Note: You can only adjust the red or blue color convergence. Green is the standard color panel and cannot be adjusted.

1. Turn on the projector.
2. Press the **Menu** button.
3. Select the **Extended** menu and press **Enter**.
4. Select the **Display** setting and press **Enter**.
5. Select the **Panel Alignment** setting and press **Enter**.

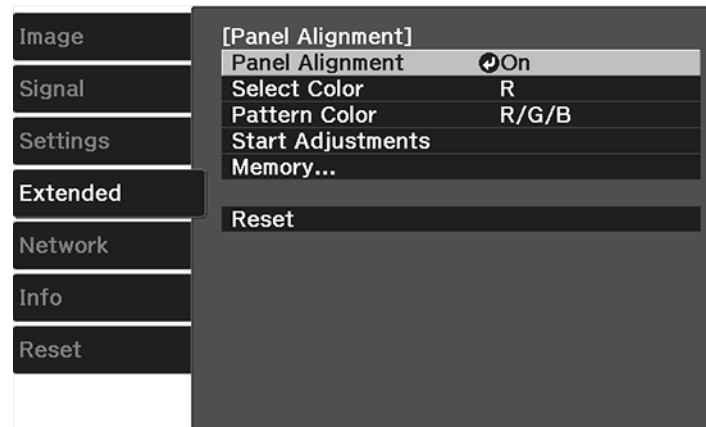

6. Select the **Panel Alignment** setting and press **Enter**.
7. Select **On** and press **Enter**.
8. Select the **Select Color** setting and choose one of the following:
 - **R** to adjust the red color convergence.
 - **B** to adjust the blue color convergence.
9. Select the **Pattern Color** setting and press **Enter**.
10. Select the pattern you want to use and press **Enter**.

11. Select **Start Adjustments** and press **Enter**.

You see this screen:

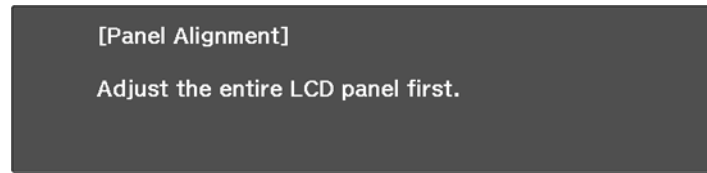

12. Press **Enter**.

You see a screen like this:

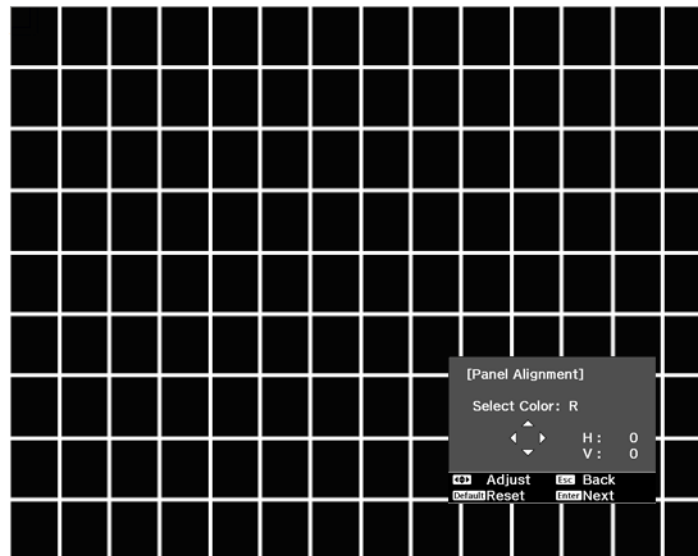

13. Use the arrow buttons on the remote control to adjust the color alignment of the color you selected for the **Select Color** setting.
14. When you are finished adjusting the screen, press **Enter**.

You see this screen:

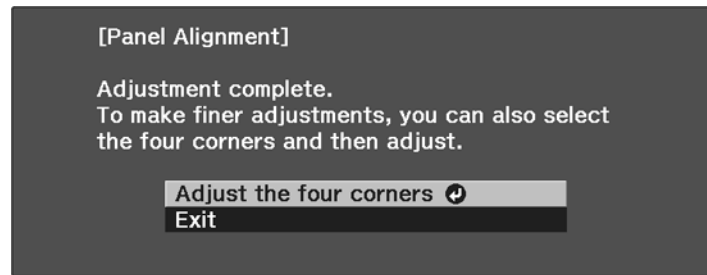

Note: Your adjustments affect the gridlines in the entire screen. To fine-tune your adjustments, continue with the next steps.

15. Select **Adjust the four corners** and press **Enter**. (Otherwise, select **Exit** and press **Enter**.)
16. Use the arrow buttons on the remote control to adjust the color alignment in the corner of the screen highlighted by the orange box.

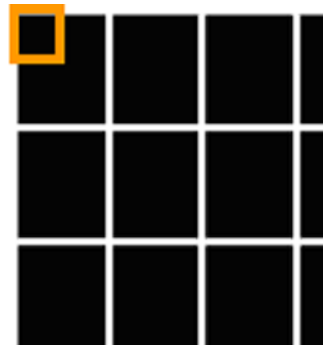

17. Press the **Enter** button to move to the next corner of the screen.
18. When you are finished adjusting each corner of the screen, press **Enter**.

You see this screen:

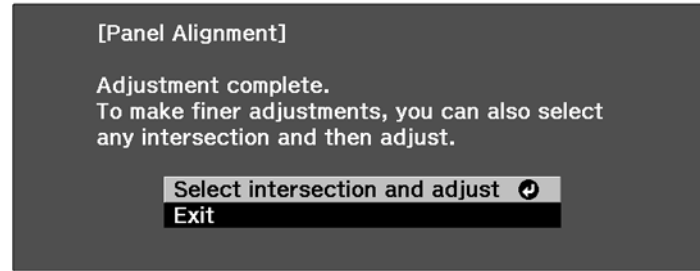

19. Do one of the following:

- If your projector's panel alignment is now correct, select **Exit** and press **Enter** to return to the Panel Alignment menu.
- If your projector needs additional panel alignment, select **Select intersection and adjust** and press **Enter**. Use the arrow keys on the remote control to highlight the corner of any misaligned box on the screen and press **Enter**. Repeat this step as necessary.

Parent topic: [Using Advanced Image Adjustment Features](#)

Adjusting the Color Tone (Color Uniformity)

You can use the Color Uniformity feature to manually adjust the color tone balance in the projected image.

1. Press the **Menu** button.

2. Select the **Extended** menu and press **Enter**.

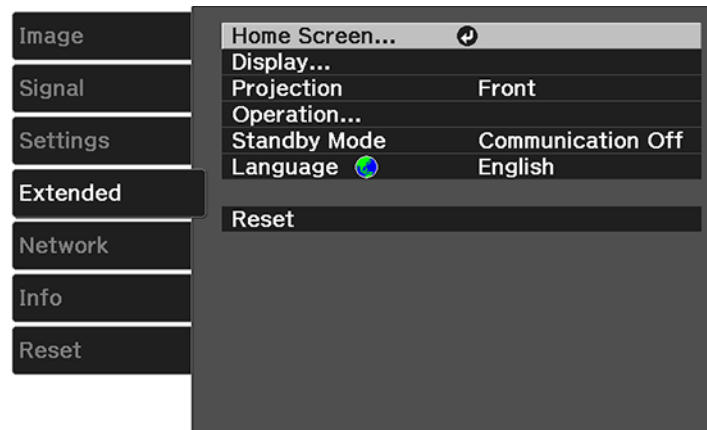

3. Select the **Display** setting and press **Enter**.
4. Select the **Color Uniformity** setting and press **Enter**.
5. Press **Enter** and select **On**.
6. Press **Esc**.
7. Select the **Adjustment Level** setting and press **Enter**.
8. Press the right and left arrow buttons to adjust the level, then press **Esc**.
9. Select the **Start Adjustments** setting and press **Enter**.

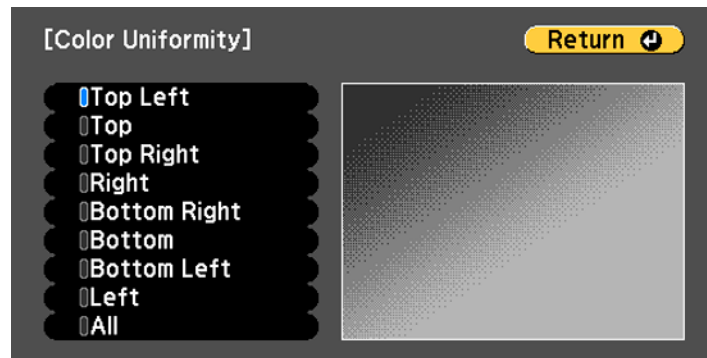

10. Select the area of the screen that you want to adjust and press **Enter**.

Note: Adjust the outer areas first, then adjust the entire screen.

11. Select the color (**Red**, **Green**, or **Blue**) you want to adjust, and use the left arrow button to weaken the color tone and the right arrow button to strengthen the color tone.

12. Press **Esc**.

13. Repeat steps 10 and 11 for each area you want to adjust.

14. Repeat steps 7 to 11 for each adjustment level.

15. When you are finished, press the **Menu** button.

Parent topic: [Using Advanced Image Adjustment Features](#)

Saving Settings to Memory and Using Saved Settings

You can save customized settings for each of your video inputs and then select the saved settings whenever you want to use them.

Note: You can save the **Image** settings and the Lens Adjustment (Focus, Zoom, and Lens Shift) function values.

1. Turn on the projector and display an image.

2. Press the **Menu** button.

Note: You can also press the **Memory** button on the remote control to access the Memory menu directly.

3. Select the **Settings** menu and press **Enter**.

4. Select the **Memory** setting and press **Enter**.

You see this screen:

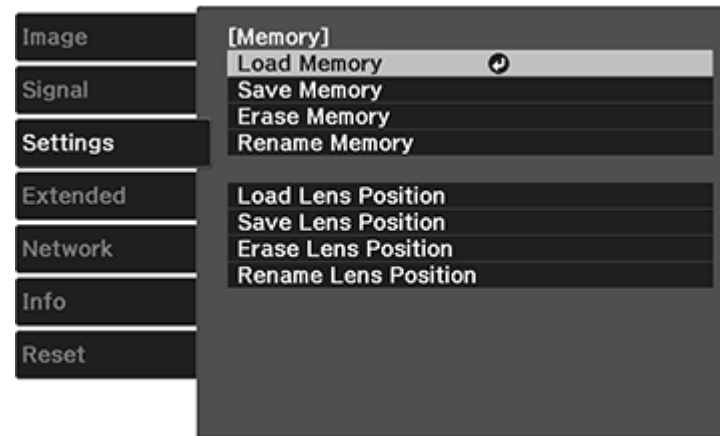

5. Select one of the following options:

- **Load Memory:** Overwrites your current settings with saved settings
- **Save Memory:** Saves your current settings to memory (10 memories with different names are available)

Note: A memory name that has already been used is indicated by a blue mark. Saving over a previously saved memory overwrites the settings with your current settings.

- **Erase Memory:** Erases the selected memory settings
- **Rename Memory:** Renames a saved memory

6. Press **Esc** to exit.

Parent topic: [Adjusting Projector Features](#)

Saving the Lens Position and Using Saved Lens Positions

You can save the focus, zoom, and lens shift settings and then select the saved settings whenever you want to use them.

1. Turn on the projector and display an image.
2. Adjust the focus, zoom, and lens shift settings.

3. Press the **Menu** button.

Note: You can also press the **Memory** button on the remote control to access the Memory menu directly.

4. Select the **Settings** menu and press **Enter**.
5. Select the **Memory** setting and press **Enter**.

You see this screen:

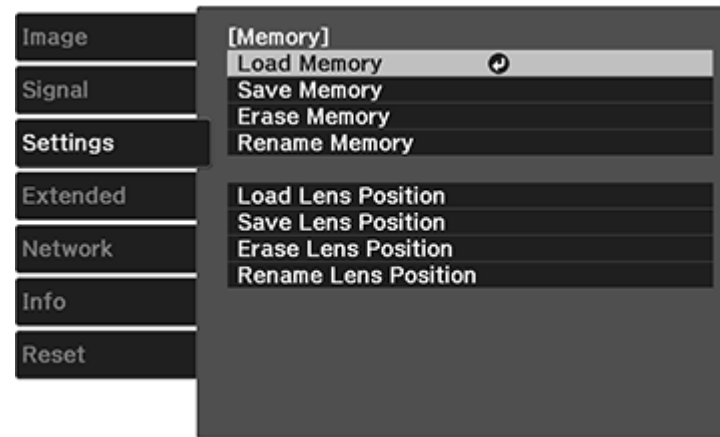

6. Select one of the following options:

- **Load Lens Position:** Overwrites your current focus, zoom, and lens shift settings with saved settings

Note: You can load the saved settings from **Memory1** or **Memory2** by pressing the **Lens1** or **Lens2** buttons on the remote control.

- **Save Lens Position:** Saves your current focus, zoom, and lens shift settings to memory (10 memories with different names are available)

Note: A memory name that has already been used is indicated by a blue mark. Saving over a previously saved memory overwrites the settings with your current settings.

- **Erase Lens Position:** Erases the selected lens position settings

- **Rename Lens Position:** Renames a saved lens position (12 characters maximum)

7. Press **Esc** to exit.

Parent topic: [Adjusting Projector Features](#)

Adjusting the Menu Settings

Follow the instructions in these sections to access the projector menu system and change projector settings.

[Using the Projector's Menus](#)

[Image Quality Settings - Image Menu](#)

[Input Signal Settings - Signal Menu](#)

[Projector Feature Settings - Settings Menu](#)

[Projector Setup Settings - Extended Menu](#)

[Projector Network Settings - Network Menu](#)

[Projector Information Display - Info Menu](#)

[Projector Reset Options - Reset Menu](#)

Using the Projector's Menus

You can use the projector's menus to adjust the settings that control how your projector works. The projector displays the menus on the screen.

1. Press the **Menu** button on the control panel or remote control.

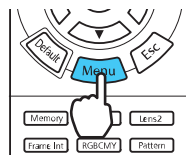
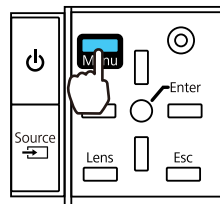

You see the menu screen displaying the Image menu settings.

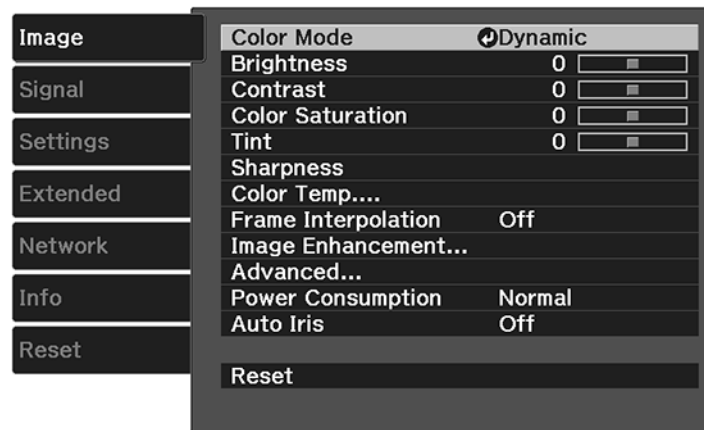

2. Press the up or down arrow button to move through the menus listed on the left. The settings for each menu are displayed on the right.

Note: The available settings depend on the current input source.

3. To change settings in the displayed menu, press **Enter**.
4. Press the up or down arrow button to move through the settings.
5. Change the settings using the buttons listed on the bottom of the menu screens.
6. To return all the menu settings to their default values, select **Reset**.
7. When you finish changing settings on a menu, press **Esc**.
8. Press **Menu** or **Esc** to exit the menus.

Parent topic: [Adjusting the Menu Settings](#)

Image Quality Settings - Image Menu

Settings on the Image menu let you adjust the quality of your image for the input source you are currently using.

Note: The available settings depend on the currently selected input source.

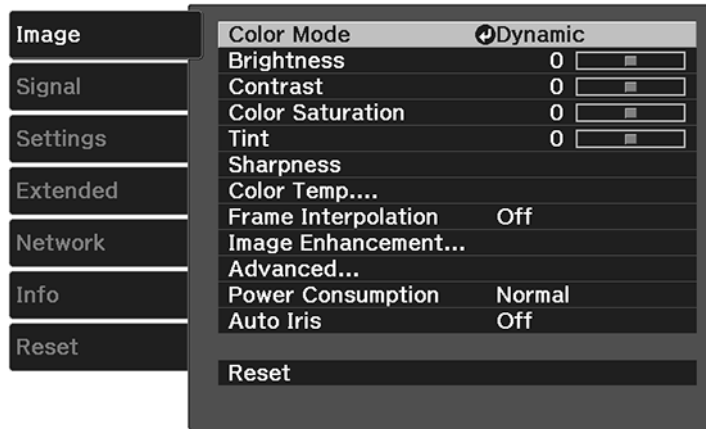

To change settings for an input source, make sure the source is connected and select that source.

Setting	Options	Description
Color Mode	See the list of available Color Modes	Adjusts the vividness of image colors for various image types and environments
Brightness	Varying levels available	Lightens or darkens the overall image
Contrast	Varying levels available	Adjusts the difference between light and dark areas of the image
Color Saturation	Varying levels available	Adjusts the intensity of the image colors
Tint	Varying levels available	Adjusts the balance of green to magenta tones in the image
Sharpness	Varying levels available	Adjusts the sharpness or softness of image details

Setting	Options	Description
Color Temp. (color temperature)	Color Temp. Skin Tone Customized	<p>Color Temp.: sets the overall color tone; higher values tint the image blue and lower values tint the image red</p> <p>Skin Tone: makes fine adjustments to the color tone; higher values tint the image green and lower values tint the image red</p> <p>Customized: adjusts the offset and gain for each RGB color</p>
Frame Interpolation	Off Weak Normal Strong	<p>Adjusts the smoothness of movement in the image</p> <p>Note: Only available for 1080p signals at 24 Hz.</p>

Setting	Options	Description
Image Enhancement	<p>4K Enhancement</p> <p>Image Preset Mode</p> <p>Noise Reduction</p> <p>MPEG Noise Reduction</p> <p>Super-resolution</p> <p>Detail Enhancement</p>	<p>4K Enhancement: accepts 4K signals and enhances the output of 1080p signals</p> <p>Image Preset Mode: selects one of five preset groups of settings for the next image enhancement options</p> <p>Noise Reduction: reduces flickering in analog images</p> <p>MPEG Noise Reduction: reduces the noise or artifacts seen in MPEG video</p> <p>Super-resolution: sharpens blurred images resulting from increasing resolution</p> <p>Detail Enhancement: enhances details to create clear outlines</p> <ul style="list-style-type: none"> • Range: higher settings increase the affected area around the outline • Strength: higher settings create a stronger effect <p>Note: Range and Strength will vary based on the Image Preset Mode setting.</p>

Setting	Options	Description
Advanced	Gamma RGBCMY Deinterlacing EPSON Super White	Selects various detailed color settings Gamma: adjusts the gamma levels of the image. Select Customized to adjust the gamma while viewing the image or a graph. RGBCMY: adjusts the hue, saturation, and brightness for each color Deinterlacing: sets whether to convert interlaced-to-progressive signals for certain video image types <ul style="list-style-type: none"> • Off: for fast-moving video images • Video: for most video images • Film/Auto: for movies, computer graphics, and animation EPSON Super White: reduces over-exposure of whites in your image
Power Consumption	High Medium ECO	Selects the brightness mode of the projector lamp High: sets maximum lamp brightness Medium: reduces the brightness of the lamp ECO: reduces lamp brightness and fan noise, and saves power and lamp life

Setting	Options	Description
Auto Iris	Off Normal High Speed	Adjusts the projected luminance based on the image brightness when certain Color Modes are selected

Note: The **Brightness** setting does not affect lamp brightness. To change the lamp brightness mode, use the **Power Consumption** setting.

Parent topic: [Adjusting the Menu Settings](#)

Related references

[Available Color Modes](#)

Input Signal Settings - Signal Menu

Normally the projector detects and optimizes the input signal settings automatically. If you need to customize the settings, you can use the Signal menu.

Note: The available settings depend on the currently selected input source. You cannot change the **Signal** menu settings when the **LAN** source is selected.

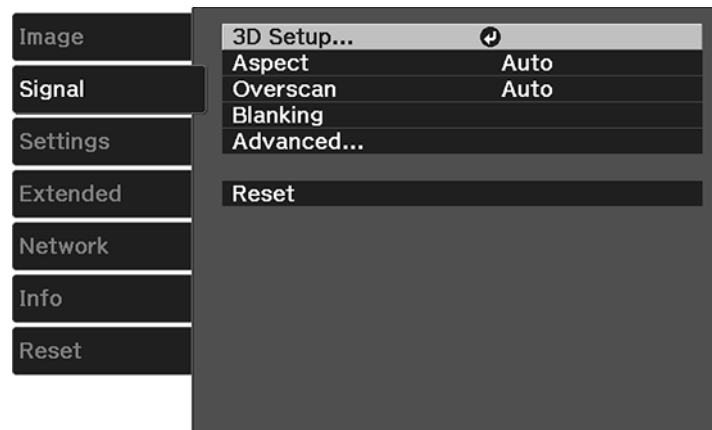

To change settings for an input source, make sure the source is connected and select that source.

Setting	Options	Description
3D Setup	3D Display 3D Format 2D-to-3D Conversion 3D Depth Diagonal Screen Size 3D Brightness Inverse 3D Glasses 3D Viewing Notice	Selects various 3D options 3D Display: enables 3D mode 3D Format: selects the 3D format 2D-to-3D Conversion: converts 2D images to 3D 3D Depth: sets the depth for the 3D image Diagonal Screen Size: selects the actual size of the screen to maximize the 3D effect 3D Brightness: adjusts the brightness of the 3D image Inverse 3D Glasses: reverses the images projected for the left and right eyes (enable only if 3D images do not display correctly) 3D Viewing Notice: enables the viewing notice displayed when using 3D mode
Aspect	See the list of available aspect ratios	Sets the aspect ratio (width-to-height ratio) for the selected input source
Tracking	Varying levels available	Adjusts signal to eliminate vertical stripes in computer images from the PC input port
Sync.	Varying levels available	Adjusts signal to eliminate fuzziness or flickering in computer images from the PC input port
Position	Up, down, left, right	Adjusts the image location on the screen

Setting	Options	Description
Auto Setup	On Off	Automatically optimizes computer image quality
Overscan	Auto Off 4% 8%	Changes the projected image ratio to make the edges visible by a selectable percentage or automatically
Blanking	Various settings	Covers part of the image with a black screen to hide raster lines at the edge of the screen. Note: Using this feature reduces the image size.
Advanced	HDMI Video Range Color Space Dynamic Range Image Processing	HDMI Video Range: sets the video range to match the setting of the device connected to the HDMI input port Color Space: sets the conversion system for the color space (Auto , BT.709 , or BT.2020) Dynamic Range: selects the HDR (High Dynamic Range) mode Image Processing: adjusts how images are processed; select Fast to display images quicker; select Fine to display images in higher quality Note: The Fast setting disables all image adjustment features.

Note: You can set the HDMI Video Range setting only when the **Epson Super White** setting is set to **Off**. The **Reset** setting does not reset the **Diagonal Screen Size**, **3D Viewing Notice**, and **Aspect** settings. The **Aspect** setting is not available for HD video signals.

Parent topic: [Adjusting the Menu Settings](#)

Related concepts

[Image Aspect Ratio](#)

Related tasks

[Viewing 3D Images](#)

Projector Feature Settings - Settings Menu

Options on the Settings menu let you customize various projector features.

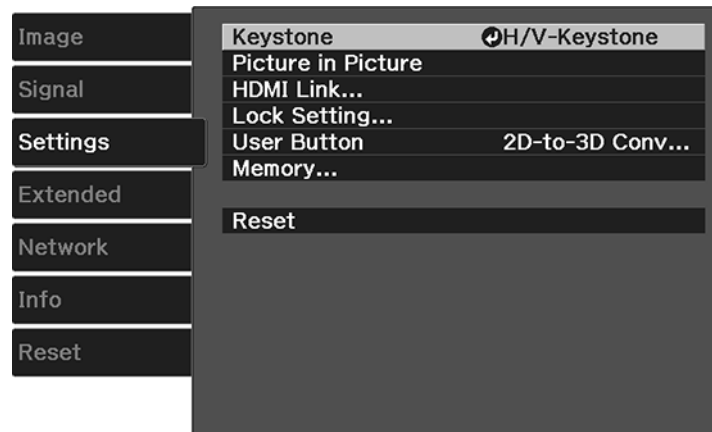

Setting	Options	Description
Keystone	Varying levels available	Adjusts image shape to rectangular (vertically)
Picture in Picture	See the list of available Picture in Picture options	Adjusts the size and location of the sub-screen, swaps sources and exits Picture in Picture mode

Setting	Options	Description
HDMI Link	Device Connections HDMI Link Power On Link Power Off Link Link Buffer	Adjusts the HDMI Link options Device Connections: lists the devices connected to the HDMI1 and HDMI2 ports HDMI Link: enables or disables the HDMI Link function Power On Link: controls what happens when you turn on the projector or a linked device <ul style="list-style-type: none"> • PJ -> Device or Bidirectional: turns on the linked device when the projector is turned on • Device -> PJ or Bidirectional: turns on the projector when the linked device is turned on Power Off Link: controls whether linked devices are turned off when the projector is turned off Link Buffer: improves weak HDMI Link connections
Lock Setting	Lens Lock Child Lock Control Panel Lock	Controls projector lens and control panel button locking to secure the projector Lens Lock: locks the focus, zoom, and lens shift settings Child Lock: locks the power button Control Panel Lock: <ul style="list-style-type: none"> • Full Lock: locks all buttons • Partial Lock: locks all buttons except the power button • Off: no buttons locked

Setting	Options	Description
User Button	Fine/Fast (Image Processing) 3D Display 2D-to-3D Conversion Power Consumption Info Display the QR Code	Assigns a menu option to the User button on the remote control for one-touch access
Memory	Load Memory Save Memory Erase Memory Rename Memory Load Lens Position Save Lens Position Erase Lens Position Rename Lens Position	Controls the saved projector settings and lens positions Load Memory: displays the list of customized settings entries that you have created Save Memory: saves the current projector settings to the projector's memory Erase Memory: erases a saved memory position Rename Memory: changes the name of a saved memory position Load Lens Position: loads lens adjustment values saved with the Save Lens Position setting Save Lens Position: saves the focus, zoom, and lens shift adjustments as a lens position entry Erase Lens Position: deletes the saved lens position entry Rename Lens Position: renames a saved lens position entry

Parent topic: [Adjusting the Menu Settings](#)

Projector Setup Settings - Extended Menu

Settings on the Extended menu let you customize various projector setup features that control its operation.

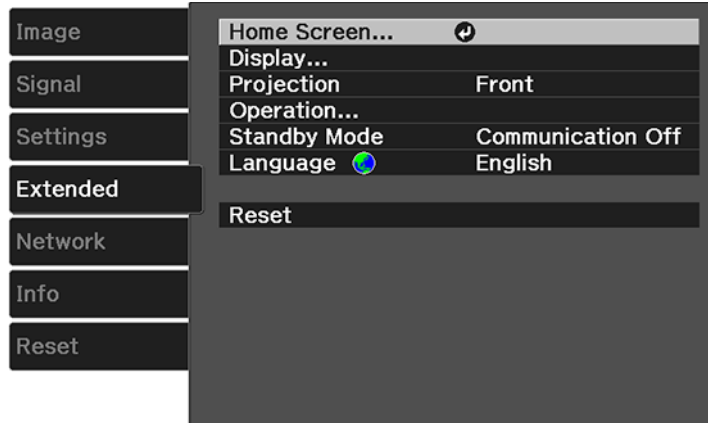

Setting	Options	Description
Home Screen	Home Screen Auto Disp. Custom Function 1 Custom Function 2	Adjust settings on the Home Screen Home Screen Auto Disp.: controls whether the Home screen displays automatically when the projector is turned on Custom Function 1 / Custom Function 2: let you customize the options displayed on the Home screen and save your settings as a preset
Display	—	See the Display settings table in this topic

Setting	Options	Description
Projection	Front Front/Ceiling Rear Rear/Ceiling	Selects the way the projector faces the screen so the image is oriented correctly
Operation	—	See the Operation settings table in this topic
Standby Mode	Communication Off Communication On	Indicates whether the projector can be monitored over a network while in standby mode
Language	Various languages available	Selects the language for projector menu and message displays (not changed by Reset option)

Display settings

Setting	Description
Menu Position	Selects the position of the projector menu displayed on the screen
Messages	Controls whether messages are displayed on the screen
Display Background	Selects the screen color or logo to display when no signal is received
Startup Screen	Controls whether a special screen appears when the projector starts up
Standby Confirmation	Displays a confirmation message after pressing the Standby button on the remote control
Panel Alignment	Corrects color misalignment in the projected image
Color Uniformity	Adjusts the color tone balance

Operation settings

Setting	Description
Direct Power On	Turns on the projector when you plug it in
Sleep Mode	Automatically places the projector in standby mode after an interval of inactivity
Sleep Mode Timer	Sets the time before the projector automatically turns off (Sleep Mode must be turned on)
Illumination	Turns off the status indicator lights on the projector
Trigger Out	Outputs a DC 12V signal at 200 mA maximum from the 3.5 mm mini-jack Trigger Out port whenever the projector is turned on
High Altitude Mode	Regulates the projector's operating temperature at altitudes above 4921 feet (1500 m)

Note: The **Reset** setting does not reset the **Memory, Projection, High Altitude Mode, Standby Mode** or **Language** settings.

Parent topic: [Adjusting the Menu Settings](#)

Related concepts

[Projection Modes](#)

Related references

[Available Image Aspect Ratios](#)

Related tasks

[Using the Home Screen](#)

[Selecting External Network Detection Settings](#)

[Using Picture in Picture](#)

[Adjusting the Color Convergence \(Panel Alignment\)](#)

[Connecting to a Trigger Out Port](#)

Projector Network Settings - Network Menu

Settings on the Network menu let you view network information and set up the projector for monitoring and control over a network.

Note: Some settings are only available if the optional wireless LAN module is installed.

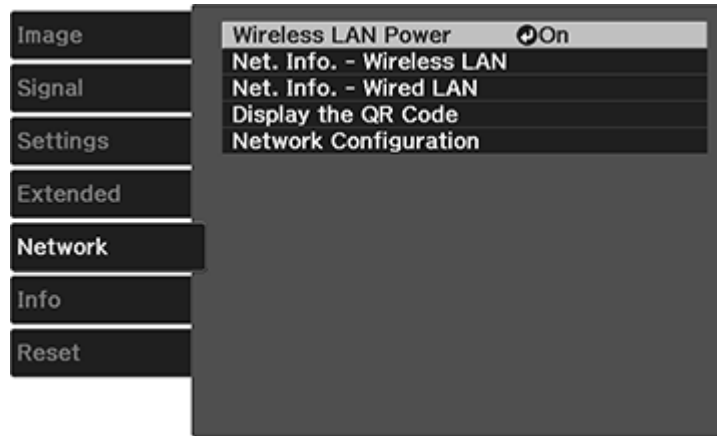

Setting	Options	Description
Wireless LAN Power	On Off	Enable or disable wireless communication
Net. Info. - Wireless LAN	Connection mode Wireless LAN Sys. Antenna level Projector Name SSID DHCP IP Address Subnet Mask Gateway Address MAC Address Region Code	Displays wireless network status and details

Setting	Options	Description
Net. Info - Wired LAN	Projector Name DHCP IP Address Subnet Mask Gateway Address MAC Address	Displays wired network status and details
Display the QR Code	—	Displays the QR Code
Network Configuration	Accesses additional network menus	Configures your network settings

Parent topic: [Adjusting the Menu Settings](#)

Related references

[Solutions When Wireless Authentication Fails](#)

Projector Information Display - Info Menu

You can display information about the projector and input sources by viewing the Info menu. However, you cannot change any settings in the menu.

Note: To view the firmware version of the projector or other components, select **Version**.

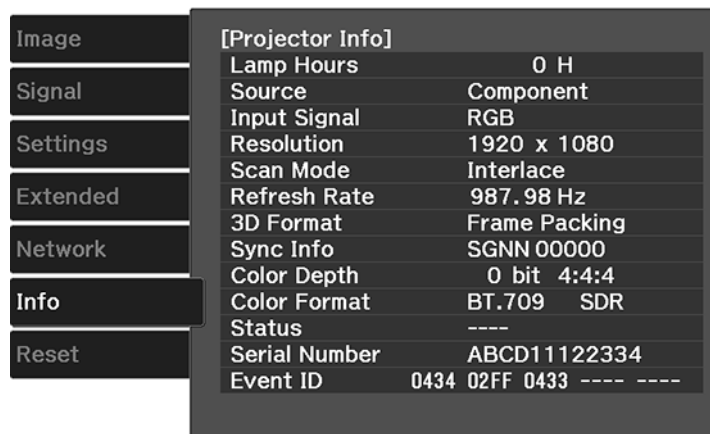

Note: Available settings depend on the current input source. The lamp usage timer does not register any hours until you have used the lamp for at least 10 hours.

Projector Info information

Information item	Description
Lamp Hours	Displays the number of hours (H) the lamp has been used
Source	Displays the name of the port to which the current input source is connected
Input Signal	Displays the input signal setting of the current input source
Resolution	Displays the resolution of the current input source
Scan Mode	Displays the scan mode of the current input source
Refresh Rate	Displays the refresh rate of the current input source
3D Format	Displays the format of the 3D signal
Sync Info	Displays information that may be needed by a service technician
Color Depth	Displays the color depth and color difference
Color Format	Displays information about the color space and dynamic range
Status	Displays information about projector problems that may be needed by a service technician
Serial Number	Displays the projector's serial number
Event ID	Displays the Event ID number corresponding to a specific projector problem; see the list of Event ID codes

[Event ID Code List](#)

Parent topic: [Adjusting the Menu Settings](#)

Related tasks

[Replacing the Lamp](#)

[Resetting the Lamp Timer](#)

Event ID Code List

If the **Event ID** option on the Info menu displays a code number, check this list of Event ID codes for the solution to the projector problem associated with the code.

Event ID code	Cause and solution	
0022	Unstable network communication. Check the network communication status, wait a few moments, and try connecting to the network again.	
0027		
0028		
0029		
0030		
0031		
0035		
0434		
0481		
0482		
0485		
0432		Turn the projector off and then on again.
0435		
0433	Cannot display the transferred images. Restart the network software.	
0484	Communication with computer was disconnected. Restart the network software.	
04FE	The network software quit unexpectedly. Check the network communication status, then turn the projector off and then on again.	
0479	A projector system error has occurred. Turn the projector off and then on again.	
04FF		
0891	Cannot find an access point with the same SSID. Set your computer, access point, and projector to the same SSID.	
0892	The WPA/WPA2 authentication type does not match. Make sure the wireless network security settings are correct.	
0894	Communication with unauthorized access point was disconnected. Contact your network administrator.	
0898	Failed to acquire DHCP. Make sure the DHCP server is operating correctly. If you are not using DHCP, turn off the DHCP setting in the Network menus.	

Event ID code	Cause and solution
0020	Communication error. Turn the projector off and then on again.
0026	
0032	
0036	
0037	
0038	
0899	

Parent topic: [Projector Information Display - Info Menu](#)

Projector Reset Options - Reset Menu

You can reset most of the projector settings to their default values using the **Reset All Config** option on the Reset menu.

You can reset the projector's lamp usage timer to zero when you replace the lamp using the **Reset Lamp Hours** option, reset the lens position entries using the **Reset Lens Position** option, and reset all memory entries using the **Reset Memory** option.

Note: The **Reset Lens Position** option does not re-center the lens; it only deletes the saved settings.

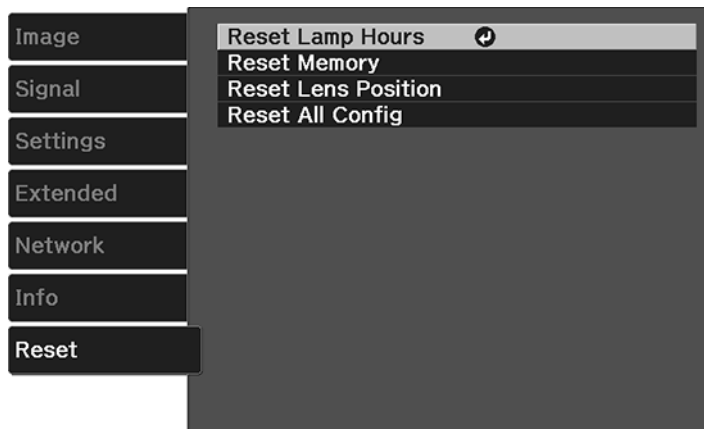

You cannot reset the following settings using the **Reset All Config** option:

- Language
- Lamp Hours
- Memory settings
- All settings in the Network menu
- Panel Alignment
- Color Uniformity

Parent topic: [Adjusting the Menu Settings](#)

Maintaining and Transporting the Projector

Follow the instructions in these sections to maintain your projector and transport it from place to place.

[Projector Maintenance](#)

[Transporting the Projector](#)

Projector Maintenance

Your projector needs little maintenance to keep working at its best.

You may need to clean the lens periodically, and clean the air filter and air vents to prevent the projector from overheating due to blocked ventilation.

The only parts you should replace are the lamp, air filter, and remote control batteries. If any other part needs replacing, contact Epson or an authorized Epson servicer.

Warning: Before cleaning any part of the projector, turn it off and unplug the power cord. Never open any cover on the projector, except as specifically explained in this manual. Dangerous electrical voltages in the projector can injure you severely.

Warning: Do not try to service this product yourself, except as specifically explained in this manual. Refer all other servicing to qualified servicers.

[Cleaning the Lens](#)

[Cleaning the Projector Case](#)

[Cleaning the 3D Glasses](#)

[Air Filter and Vent Maintenance](#)

[Projector Lamp Maintenance](#)

[Replacing the Remote Control Batteries](#)

Parent topic: [Maintaining and Transporting the Projector](#)

Cleaning the Lens

Clean the projector's lens periodically, or whenever you notice dust or smudges on the surface.

Note: If the projector has been in use, wait 30 minutes before cleaning the lens.

- To remove dust or smudges, gently move the shutter to the side and wipe the lens with lens-cleaning paper. After cleaning, close the shutter.
- To remove stubborn smudges, moisten a soft, lint-free cloth with lens cleaner and gently wipe the lens. Do not spray any liquid directly on the lens.

Warning: Do not use a lens cleaner that contains flammable gas. The high heat generated by the projector lamp may cause a fire.

Caution: Do not use glass cleaner or any harsh materials to clean the lens and do not subject the lens to any impacts; you may damage it. Do not use canned air, or the gases may leave a residue. Avoid touching the lens with your bare hands to prevent fingerprints on or damage to the lens surface.

Parent topic: [Projector Maintenance](#)

Cleaning the Projector Case

Before cleaning the projector case, turn off the projector and unplug the power cord.

Note: If the projector has been in use, wait 30 minutes before cleaning it.

- To remove dust or dirt, use a soft, dry, lint-free cloth.
- To remove stubborn dirt, use a soft cloth moistened with water and mild soap. Do not spray liquid directly on the projector.

Caution: Do not use wax, alcohol, benzene, paint thinner, or other chemicals to clean the projector case. These can damage the case. Do not use canned air, or the gases may leave a flammable residue.

Parent topic: [Projector Maintenance](#)

Cleaning the 3D Glasses

To remove dust, dirt, smudges, or fingerprints from the glasses, use a soft, dry, lint-free cloth.

Note: Unplug any charging cables from the glasses before cleaning them.

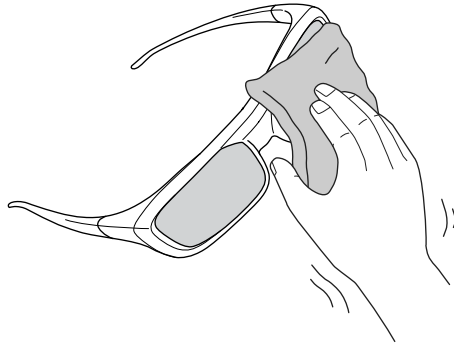

Caution: Do not use paper towels or any other abrasive materials to clean the glasses.

Parent topic: [Projector Maintenance](#)

Air Filter and Vent Maintenance

Regular filter maintenance is important to maintaining your projector. Your Epson projector is designed with an easily accessible, user-replaceable filter to protect your projector and make regular maintenance simple. Filter maintenance intervals will depend on the environment.

If regular maintenance is not performed, your Epson projector will notify you when the temperature inside the projector has reached a high level. Do not wait until this warning appears to maintain your projector filter as prolonged exposure to high temperatures may reduce the life of your projector or lamp.

Damage due to the failure to properly maintain the projector or its filter may not be covered by the projector or lamp Limited Warranties.

[Cleaning the Air Filter](#)

[Replacing the Air Filter](#)

Parent topic: [Projector Maintenance](#)

Related references

[Projector Light Status](#)

Cleaning the Air Filter

You need to clean the projector's air filter in the following situations:

- The filter or vents get dusty.

- You see a message telling you to clean it.
1. Turn off the projector and unplug the power cord.
 2. Press and hold the tab on the air filter cover, and pull to remove the cover.

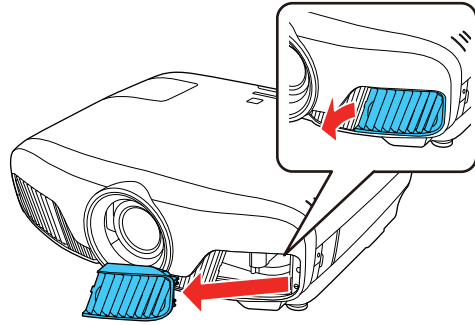

3. Pull the air filter out of the projector.

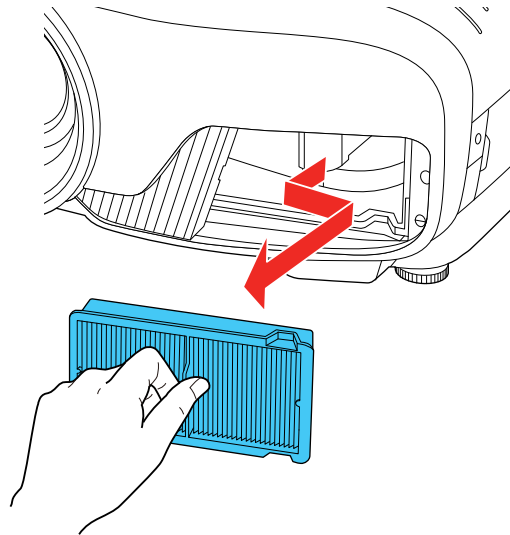

4. Tap each side of the air filter 4 to 5 times to shake off any excess dust.

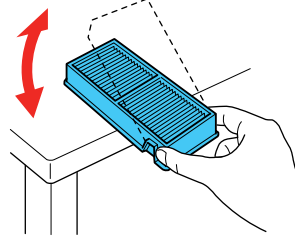

Caution: Do not use excessive force when tapping the air filter, or it may crack and become unusable. Do not rinse the air filter in water, or use any detergent or solvent to clean it. Do not use canned air; the gases may leave a residue, or push dust and debris into the projector's optics or other sensitive areas.

5. Vacuum the front of the air filter (the side with the tabs) to remove any remaining dust.

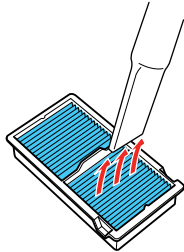

Note: If dust is difficult to remove or the air filter is damaged, replace the air filter.

6. Place the air filter back in the projector as shown.

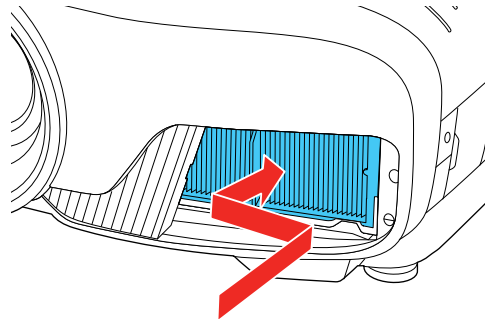

7. Attach the air filter cover as shown.

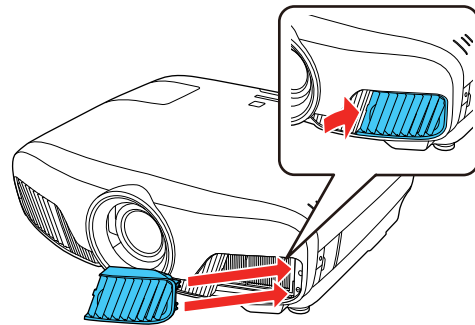

Parent topic: [Air Filter and Vent Maintenance](#)

Related tasks

[Replacing the Air Filter](#)

Replacing the Air Filter

You need to replace the air filter in the following situations:

- After cleaning the air filter, you see a message telling you to clean or replace it
- The air filter is torn or damaged

You can replace the air filter while the projector is mounted to the ceiling or placed on a table.

1. Turn off the projector and unplug the power cord.

2. Press and hold the tab on the air filter cover, and pull to remove the cover.

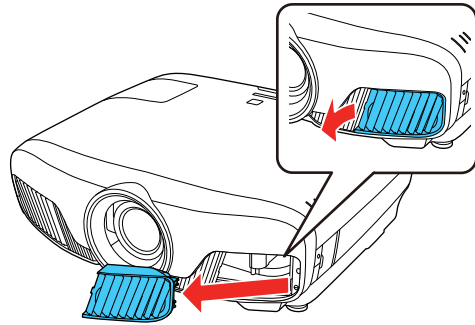

3. Pull the air filter out of the projector.

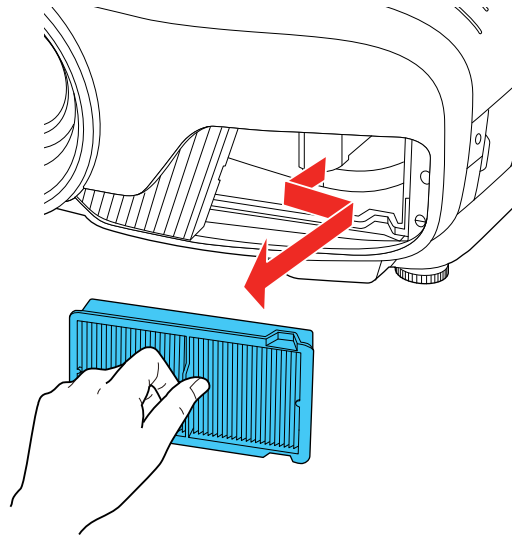

Note: Air filters contain polypropylene. Dispose of used air filters according to local regulations.

4. Place the new air filter in the projector as shown.

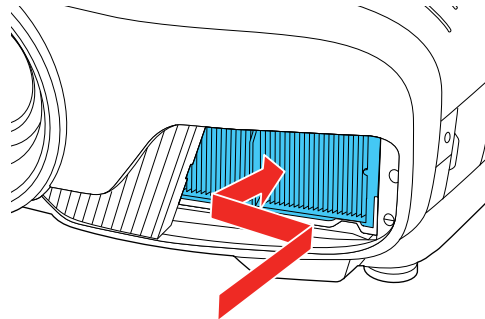

5. Attach the air filter cover as shown.

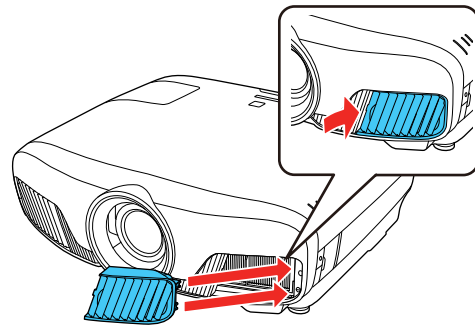

Parent topic: [Air Filter and Vent Maintenance](#)

Projector Lamp Maintenance

The projector keeps track of the number of hours the lamp is used and displays this information in the projector's menu system.

Replace the lamp as soon as possible when the following occurs:

- The projected image gets darker or starts to deteriorate
- A message appears when you turn on the projector telling you to replace the lamp

[Replacing the Lamp](#)

[Resetting the Lamp Timer](#)

Parent topic: [Projector Maintenance](#)

Related references

[Projector Information Display - Info Menu](#)

[Projector Lamp Specifications](#)

[Optional Equipment and Replacement Parts](#)

Replacing the Lamp

Before you replace the lamp, let the projector cool down for at least one hour so the lamp will not be hot.

Warning: Let the lamp fully cool before replacing it to avoid injury.

You can replace the lamp while the projector is mounted to the ceiling, if necessary.

1. Turn off the projector and unplug the power cord.
2. Allow the projector lamp to cool down for at least one hour.
3. Use the screwdriver included with the replacement lamp to loosen the screw securing the lamp cover.

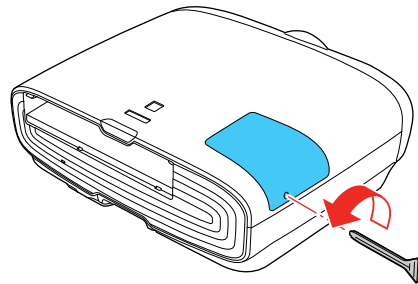

Warning: If the lamp is broken, glass fragments may be loose inside the lamp chamber. Be careful removing any broken glass to avoid injury. If the projector is installed on the ceiling, stand to the side of the lamp cover and not underneath it; pieces of glass could fall into your eyes or mouth when you open the lamp cover.

4. Slide the lamp cover out and lift it off.

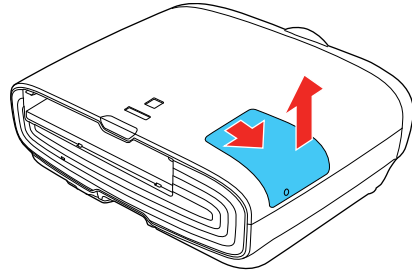

5. Loosen the screws securing the lamp to the projector. The screws do not come all the way out.

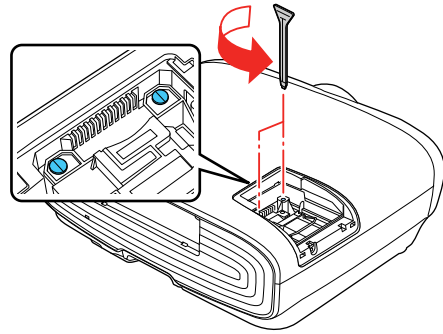

6. Lift up the lamp handle and gently pull the lamp out of the projector.

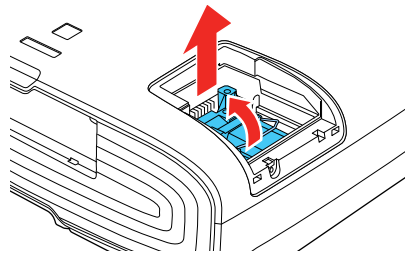

Note: (Hg) The lamp(s) in this product contain mercury. Please consult your state and local regulations regarding disposal or recycling. Do not put in the trash.

7. Gently insert the new lamp into the projector. If it does not fit easily, make sure it is facing the right way. Lower the handle.

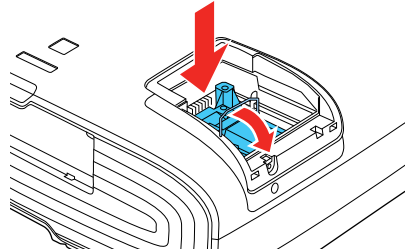

Caution: Do not touch any glass on the lamp assembly to avoid premature lamp failure.

8. Push in the lamp firmly and tighten the screws to secure it.

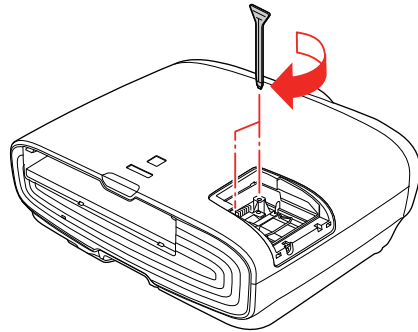

Caution: Do not over-tighten the screws.

9. Replace the lamp cover and tighten the screw to secure it.

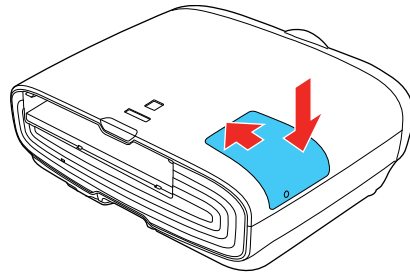

Note: Be sure the lamp cover is securely installed or the lamp will not come on.

Reset the lamp timer to zero to keep track of the new lamp's usage.

Parent topic: [Projector Lamp Maintenance](#)

Related tasks

[Resetting the Lamp Timer](#)

Resetting the Lamp Timer

You must reset the lamp timer after replacing the projector's lamp to clear the lamp replacement message and to keep track of lamp usage correctly.

Note: Do not reset the lamp timer if you have not replaced the lamp to avoid inaccurate lamp usage information.

1. Turn on the projector.
2. Press the **Menu** button.

3. Select the **Reset** menu and press **Enter**.

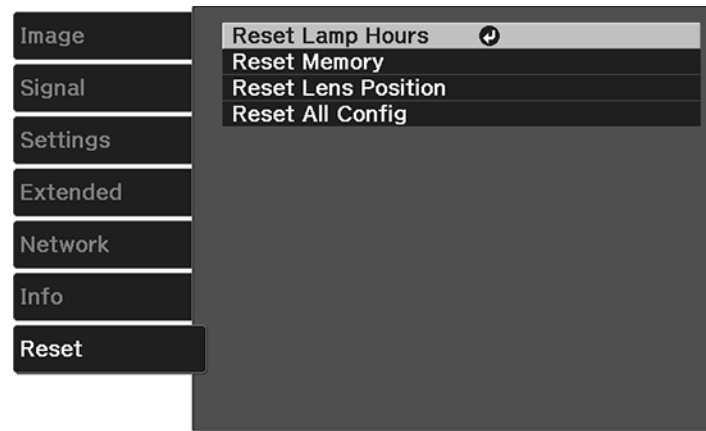

4. Select **Reset Lamp Hours** and press **Enter**.
You see a prompt asking if you want to reset the lamp hours.
5. Select **Yes** and press **Enter**.
6. Press **Menu** or **Esc** to exit the menus.

Parent topic: [Projector Lamp Maintenance](#)

Replacing the Remote Control Batteries

The remote control uses two AA manganese or alkaline batteries. Replace the batteries as soon as they run out.

Caution: Use only the type of batteries specified in this manual. Do not install batteries of different types, or mix new and old batteries.

1. Remove the battery cover as shown.

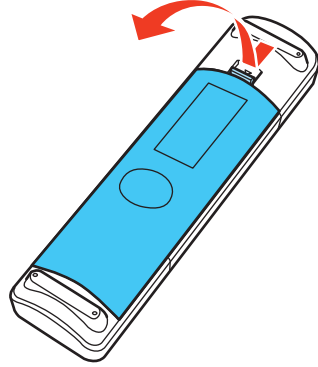

2. Remove the old batteries.

Warning: If the battery fluid has leaked, wipe it away with a soft cloth and avoid getting the fluid on your hands. If it gets on your hands, wash them immediately to avoid injury.

3. Insert the batteries with the + and – ends facing as shown.

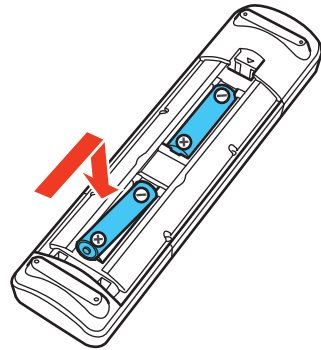

4. Replace the battery cover and press it down until it clicks into place.

Warning: Dispose of used batteries according to local regulations. Do not expose batteries to heat or flame. Keep batteries out of the reach of children; they are choking hazards and are very dangerous if swallowed.

Parent topic: [Projector Maintenance](#)

Related references

[Remote Control Specifications](#)

Transporting the Projector

The projector contains precision parts, some of which are glass. Follow these guidelines to transport, ship, or store the projector safely:

- Remove any equipment connected to the projector.
- Center the lens position using the **Lens** button.

Caution: If you transport the projector when the lens is not centered, the lens shift mechanism may be damaged.

- When transporting the projector a long distance or as checked luggage, pack it in a firm box with cushioning around it and mark the box "Fragile."
- When shipping the projector for repairs, place it in its original packing materials, if possible, or use equivalent materials with cushioning around the projector. Mark the box "Fragile."

Note: Epson shall not be liable for any damages incurred during transportation.

Parent topic: [Maintaining and Transporting the Projector](#)

Related tasks

[Turning Off the Projector](#)

Solving Problems

Check the solutions in these sections if you have any problems using the projector.

[Projection Problem Tips](#)

[Projector Light Status](#)

[Solving Image Problems](#)

[Solving Projector or Remote Control Operation Problems](#)

[Solutions When Wireless Authentication Fails](#)

[Where to Get Help](#)

Projection Problem Tips

If the projector is not working properly, try turning it off and unplugging it. Then plug it back in and turn it on.

If this does not solve the problem, check the following:

- The lights on the projector may indicate what the problem is.
- The solutions in this manual can help you solve many problems.

If none of these solutions help, you can contact Epson for technical support.

Parent topic: [Solving Problems](#)

Projector Light Status

The lights on the projector indicate the projector status and let you know when a problem occurs. Check the status and color of the lights and look for a solution in the table here.

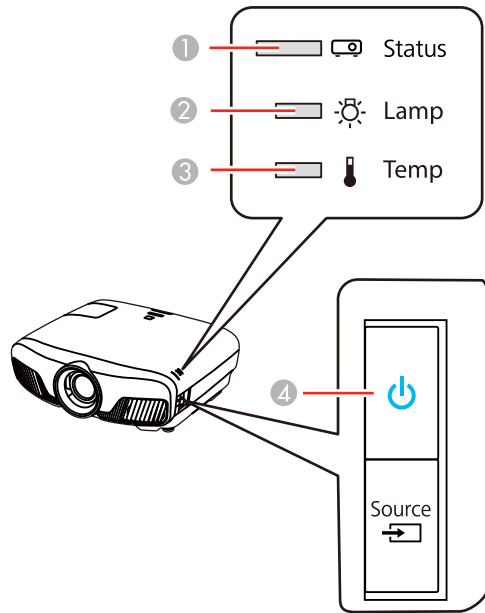

- 1 Status light
- 2 Lamp light
- 3 Temp light
- 4 Power light

Power light	Status light	Lamp light	Temp light	Status and solution
Blue	Blue	Off	Off	Normal operation

Power light	Status light	Lamp light	Temp light	Status and solution
Blue	Flashing blue	Off	Off	Warming up; wait for an image to appear
				Shutting down; when the Status light stops flashing, you can unplug the projector
Off	Off	Off	Off	Standby or sleep mode
Blue	Varies	Off	Flashing orange	<p>Projector is too hot</p> <ul style="list-style-type: none"> • Make sure that the vents and air filter are not clogged with dust or obstructed by nearby objects • Clean or replace the air filter • Make sure the environmental temperature is not too hot
Off	Flashing blue	Off	Orange	<p>Projector has overheated and turned off; leave it turned off to cool down for about five minutes; after the fan has stopped, do the following:</p> <ul style="list-style-type: none"> • Make sure that the vents and air filter are not clogged with dust or obstructed by nearby objects • Clean or replace the air filter • If operating the projector at high altitude, turn on High Altitude Mode • If the problem persists, unplug the projector and contact Epson for help

Power light	Status light	Lamp light	Temp light	Status and solution
Off	Flashing blue	Orange	Off	Lamp has a problem <ul style="list-style-type: none"> • Check the Lamp Hours in the Info menu to see if the lamp is burned out. Unplug the projector, wait for the lamp to cool down, and check if it is broken or installed incorrectly; reseal or replace the lamp as necessary • Clean or replace the air filter • Make sure the lamp cover is closed • If operating the projector at high altitude, turn on High Altitude Mode • If the problem persists, unplug the projector and contact Epson for help
Blue	Varies	Flashing orange	Off	Replace the lamp soon to avoid damage; do not continue using the projector
Off	Flashing blue	Off	Flashing orange	A fan or sensor has a problem; turn the projector off, unplug it, and contact Epson for help
Off	Flashing blue	Flashing orange	Flashing orange	Auto Iris or Cinema Filter error; turn the projector off, unplug it, and contact Epson for help
Off	Flashing blue	Orange	Orange	Power error; turn the projector off, unplug it, and contact Epson for help
Off	Flashing blue	Flashing orange	Off	Internal projector error; turn the projector off, unplug it, and contact Epson for help

Note: If the lights display a pattern not listed in the table above, turn the projector off, unplug it, and contact Epson for help.

Parent topic: [Solving Problems](#)

Related references

[Projector Setup Settings - Extended Menu](#)

Related tasks

[Cleaning the Air Filter](#)

[Replacing the Lamp](#)

[Replacing the Air Filter](#)

Solving Image Problems

Check the solutions in these sections if you have any problems with projected images.

[Solutions When No Image Appears](#)

[Solutions When "No Signal" Message Appears](#)

[Solutions When "Not Supported" Message Appears](#)

[Solutions When Only a Partial Image Appears](#)

[Solutions When the Image is Not Rectangular](#)

[Solutions When the Image Contains Noise or Static](#)

[Solutions When the Image is Fuzzy or Blurry](#)

[Solutions When the Image Brightness or Colors are Incorrect](#)

[Solutions When a 3D Image Does Not Display Correctly](#)

Parent topic: [Solving Problems](#)

Solutions When No Image Appears

If no image appears, try the following solutions:

- Make sure the lens cover is open all the way.
- Press the **Blank** button on the remote control to see if the image was temporarily turned off.
- Make sure all necessary cables are securely connected and the power is on for the projector and connected video sources.
- Press the projector's power button to wake it from standby or sleep mode. Also see if your connected computer is in sleep mode or displaying a blank screen saver.
- Press the **Menu** button. If the projector menu is able to display, there may be a problem with the connected video source, cable connection, or port.
- Check the settings on the Signal menu to make sure they are correct for the current video source.

- Adjust the **Brightness** setting or select the **Normal** Power Consumption setting.
- Check the **Display** setting to make sure **Messages** is set to **On**.
- For images projected with Windows Media Center, reduce the screen size from full screen mode.
- For images projected from applications using Windows DirectX, turn off DirectX functions.
- If the other solutions do not solve the problem, reset all of the projector settings using the options on the **Reset** menu.

Parent topic: [Solving Image Problems](#)

Related references

[Image Quality Settings - Image Menu](#)

[Projector Setup Settings - Extended Menu](#)

[Input Signal Settings - Signal Menu](#)

Related tasks

[Unlocking the Projector's Buttons](#)

Solutions When "No Signal" Message Appears

If the "No Signal" message appears, try the following solutions:

- Press the **Source** button on the projector repeatedly to cycle through the available sources. Wait a few seconds for an image to appear.
- Press a source button on the remote to select an available source. Wait a few seconds for an image to appear.
- Press the **Home** button on the remote control to select from a list of available sources.
- Turn on the connected computer or video source, and press its play button to begin your presentation, if necessary.
- Check the connection from the projector to your video sources.
- If you are projecting from a laptop computer, make sure it is set up to display on an external monitor.
- If necessary, turn the projector and the connected computer or video source off and then on again.
- If the other solutions do not solve the problem, reset all of the projector settings using the options on the **Reset** menu.

[Displaying From a PC Laptop](#)

[Displaying From a Mac Laptop](#)

Parent topic: [Solving Image Problems](#)

Related concepts

[Projector Connections](#)

Displaying From a PC Laptop

If you see the "No Signal" message when you display from a PC laptop, you need to set up the laptop to display on an external monitor.

1. Hold down the laptop's **Fn** key and press the key labeled with a monitor icon or **CRT/LCD**. (See your laptop manual for details.) Wait a few seconds for an image to appear. To display on both the laptop's monitor and the projector, try pressing the same keys again.

Note: On Windows 7 or later, hold down the Windows key and press **P** at the same time, then click **Duplicate**.

2. If the same image is not displayed by the laptop and projector, check the Windows **Display** utility to make sure the external monitor port is enabled and extended desktop mode is disabled. (See your computer or Windows manual for instructions.)
3. If necessary, check your video card settings and set the multiple display option to **Clone**, **Mirror**, or **Duplicate**.

Parent topic: [Solutions When "No Signal" Message Appears](#)

Displaying From a Mac Laptop

If you see the "No Signal" message when you display from a Mac laptop, you need to set up the laptop for mirrored display. (See your laptop manual for details.)

1. Open the **System Preferences** utility and select **Displays**, **Display**, or **Color LCD**.
2. Click the **Arrange** or **Arrangement** tab.
3. Select the **Mirror Displays** checkbox.

Parent topic: [Solutions When "No Signal" Message Appears](#)

Solutions When "Not Supported" Message Appears

If the "Not Supported" message appears, try the following solutions:

- Set the computer's display resolution to the native resolution of the projector.
- Make sure the computer's display resolution does not exceed the projector's resolution and frequency limit. If necessary, select a different display resolution for your computer. (See your computer manual for details.)

- As a test, try setting the computer's display resolution to the lowest possible setting, and then gradually increase it as necessary.
- Check the input resolution under **Projector Info** in the **Info** menu and make sure that the projector supports that resolution.

Parent topic: [Solving Image Problems](#)

Related references

[Input Signal Settings - Signal Menu](#)

[Projector Setup Settings - Extended Menu](#)

[Supported Video Display Formats](#)

Solutions When Only a Partial Image Appears

If only a partial computer image appears, try the following solutions:

- Try adjusting the image position using the **Position** menu setting.
- Try adjusting the image position using the **Lens** button on the remote control or control panel.
- Press the **Aspect** button on the remote control to select a different image aspect ratio.
- Select a different image aspect ratio in the Signal menu.
- Check the cables connecting the computer or video source to the projector. Try connecting different cables.
- Check your computer display settings to disable dual display and set the resolution within the projector's limits. (See your computer manual for details.)
- Check the resolution assigned to your presentation files to see if they are created for a different resolution than you are projecting in. (See your software help for details.)

Parent topic: [Solving Image Problems](#)

Related references

[Input Signal Settings - Signal Menu](#)

[Supported Video Display Formats](#)

Solutions When the Image is Not Rectangular

If the projected image is not evenly rectangular, try the following solutions:

- Place the projector directly in front of the center of the screen, facing it squarely, if possible.
- Try to fix the image using lens shift before adjusting the **Keystone** setting.

- If you adjusted the projector height using the projector feet, press the keystone buttons on the projector to adjust the image shape.
- Adjust the image shape using the **Keystone** menu setting.

Parent topic: [Solving Image Problems](#)

Related references

[Projector Feature Settings - Settings Menu](#)

Related tasks

[Correcting Image Shape With the Keystone Buttons](#)

Solutions When the Image Contains Noise or Static

If the projected image seems to contain electronic interference (noise) or static, try the following solutions:

- Check the cables connecting your computer or video source to the projector. They should be:
 - Separated from the power cord to prevent interference
 - Securely connected at both ends
 - Not connected to an extension cable
 - No longer than 9.8 feet (3 m) for VGA/computer cables or 24 feet (7.3 m) for HDMI cables
- Check the settings on the projector's Signal menu to make sure they match the video source. If available for your video source, adjust the **Deinterlacing** and **Noise Reduction** settings.
- Select a computer video resolution and refresh rate that are compatible with the projector.
- If you are projecting from a computer using a VGA cable, display a uniformly patterned image on the screen and manually adjust the **Tracking** and **Sync** settings.
- If you adjusted the image shape using the projector controls, try decreasing the **Sharpness** setting to improve image quality.
- If you connected an extension power cable, try projecting without it to see if it caused interference in the signal.
- Try a different cable.
- Try turning off **Frame Interpolation** or turning on **Image Enhancement** in the Image menu.

Parent topic: [Solving Image Problems](#)

Related references

[Image Quality Settings - Image Menu](#)

Solutions When the Image is Fuzzy or Blurry

If the projected image is fuzzy or blurry, try the following solutions:

- Adjust the image focus.
- Clean the projector lens.
- Check the lens for condensation.

Note: To avoid condensation on the lens after bringing the projector in from a cold environment, let the projector warm up to room temperature before using it.

- Position the projector close enough to the screen, and directly in front of it.
- Position the projector so the keystone adjustment angle is not so wide that it distorts the image.
- Adjust the **Sharpness** setting to improve image quality.
- If you are projecting from a computer, display a uniformly patterned image on the screen and adjust the **Tracking** and **Sync** settings.
- If you are projecting from a computer, adjust the computer's resolution to match the projector's native resolution, if possible.
- Check the resolution of your video source. If you are projecting from a standard definition video source, your image will not be as clear as an HD (720p/1080i/1080p) video source.

Parent topic: [Solving Image Problems](#)

Related references

[Image Quality Settings - Image Menu](#)

[Projection Distance](#)

Related tasks

[Focusing the Image with the Lens Button](#)

[Cleaning the Lens](#)

Solutions When the Image Brightness or Colors are Incorrect

If the projected image is too dark or light, or the colors are incorrect, try the following solutions:

- Press the **Color Mode** button on the remote control to try different color modes for the image and environment.
- Check your video source settings.
- Adjust the available settings on the Image menu for the current input source, such as **Brightness**, **Contrast**, **Tint**, **Advanced**, and **Color Saturation**.
- Turn off the HDR mode in the **Dynamic Range** setting or set the **Color Space** setting to **BT.709**.
- For HDR images, set the **Dynamic Range** setting to **Auto (Bright)**
- Make sure all the cables are securely connected to the projector and your video device. If you connected long cables, try connecting shorter cables.
- Position the projector close enough to the screen.
- If the image has been progressively darkening, you may need to replace the projector lamp soon.

Parent topic: [Solving Image Problems](#)

Related references

[Image Quality Settings - Image Menu](#)

[Projector Setup Settings - Extended Menu](#)

[Input Signal Settings - Signal Menu](#)

Solutions When a 3D Image Does Not Display Correctly

If a 3D image does not display correctly, try the following solutions:

- Make sure the **3D Display** setting on the Signal menu is set to **Auto** or **3D**.
- Make sure your video device and media are both 3D-compatible. Refer to the documentation that came with your video device for more information.
- Make sure you are using an HDMI cable that supports 3D signals.
- Make sure you selected the correct **3D Format** setting on the Signal menu. Normally this should be set to **Auto**, but in some cases you may need to select a different setting to match the 3D signal from your video device.
- Make sure you are using RF 3D active shutter glasses. You can purchase them from Epson.
- Make sure your 3D glasses are turned on and fully charged. If the glasses have entered standby mode, slide the power switch on the glasses to the **Off** position and then back to the **On** position.

- Make sure your 3D glasses are paired with the projector.
- Adjust the **3D Depth** setting on the Signal menu.
- Make sure you are within the 3D viewing range.
- To minimize 3D crosstalk, reduce the brightness of 3D images by selecting the following settings:
 - **Color Mode: 3D Cinema**
 - **3D Brightness: Low**
 - **3D Depth: 0**
 - **HDMI Video Range: Normal**
- Make sure your screen size matches the **Diagonal Screen Size** setting on the Signal menu.
- Avoid using the projector near wireless networks, microwave ovens, 2.4 GHz cordless phones, or other devices that use the 2.4 GHz frequency band. These devices can interfere with the signal between the projector and the 3D glasses.
- If the other solutions do not solve the problem, change the **Inverse 3D Glasses** setting on the Signal menu. Return the setting to its original value if changing it does not solve the problem as it can adversely affect the 3D image.

Parent topic: [Solving Image Problems](#)

Related references

[Projector Feature Settings - Settings Menu](#)

[Image Quality Settings - Image Menu](#)

[Input Signal Settings - Signal Menu](#)

[Optional Equipment and Replacement Parts](#)

[3D Viewing Range](#)

Related tasks

[Pairing the 3D Glasses with the Projector](#)

[Charging the 3D Glasses](#)

[Cleaning the 3D Glasses](#)

Solving Projector or Remote Control Operation Problems

Check the solutions in these sections if you have problems operating the projector or remote control.

[Solutions to Projector Power or Shut-Off Problems](#)

[Solutions to Problems with the Remote Control](#)

[Solutions to Panel Alignment Problems](#)

[Solutions When Using HDMI Link](#)

Parent topic: [Solving Problems](#)

Solutions to Projector Power or Shut-Off Problems

If the projector does not come on when you press the power button or it shuts off unexpectedly, try the following solutions:

- Make sure the power cord is securely connected to the projector and to a working electrical outlet.
- The projector's buttons may be locked for security. Unlock the buttons or use the remote control to turn on the projector.
- If the projector's lamp shuts off unexpectedly, it may have entered standby mode after a period of inactivity. Press the power button to wake the projector and adjust the **Sleep Mode Timer** setting to change the sleep interval.
- Make sure the projector is not receiving shut down requests over CEC from connected devices.
- If the power button on the remote control does not turn on the projector, check its batteries and make sure the **Remote Receiver** setting is turned on in the projector's menu, if available.
- The power cord may be defective. Try another power cord. If that doesn't work, disconnect the cord and contact Epson.
- Make sure the lamp and lamp cover are installed correctly.

Parent topic: [Solving Projector or Remote Control Operation Problems](#)

Related references

[Where to Get Help](#)

[Projector Light Status](#)

[Projector Feature Settings - Settings Menu](#)

Related tasks

[Replacing the Remote Control Batteries](#)

[Unlocking the Projector's Buttons](#)

[Replacing the Lamp](#)

Solutions to Problems with the Remote Control

If the projector does not respond to remote control commands, try the following solutions:

- Check that the remote control batteries are installed correctly and have power. If necessary, replace the batteries.
- Make sure you are operating the remote control within the reception angle and range of the projector.
- Make sure the projector is not warming up or shutting down.
- Check to see if a button on the remote control is stuck down, causing it to enter sleep mode. Release the button to wake the remote control up.
- Strong fluorescent lighting, direct sunlight, or infrared device signals may be interfering with the projector's remote receivers. Dim the lights or move the projector away from the sun or interfering equipment.
- If available, turn on one of the remote receivers in the projector's menu system, or check if all the remote receivers were turned off.
- If you assigned an ID number to the remote control to operate multiple projectors, you may need to check or change the ID setting (feature not available with all projectors).
- If you lose the remote control, you can purchase another from an authorized Epson reseller.

Parent topic: [Solving Projector or Remote Control Operation Problems](#)

Related references

[Optional Equipment and Replacement Parts](#)

[Remote Control Operation](#)

Related tasks

[Replacing the Remote Control Batteries](#)

Solutions to Panel Alignment Problems

If the panel alignment does not result in a satisfactory picture, try the following solutions:

- Make sure the **Projection** setting matches the installation position.
- Make sure the projection surface is not colored or textured. Project on a white surface with no texture.
- Leave the projector on for 10 to 15 minutes before adjusting the panel alignment.
- The projected image size should be at least 60 inches (152 cm) during panel alignment.
- If the image contains too much magenta, adjust the red and blue panels.
- If the pattern lines look fuzzy or out of focus, adjust the focus before performing the panel alignment.

Parent topic: [Solving Projector or Remote Control Operation Problems](#)

Related references

[Projector Feature Settings - Settings Menu](#)

Related tasks

[Adjusting the Color Convergence \(Panel Alignment\)](#)

[Focusing the Image with the Lens Button](#)

Solutions When Using HDMI Link

If you cannot control an HDMI device using the HDMI Link buttons, try the following solutions:

- Make sure all necessary cables are securely connected and the power is on for the projector and connected video sources.
- Make sure the cables meet the HDMI standards.
- Make sure the connected device supports the CEC standards.
- If you connected a new device or changed any connections, you may need to restart the device.
- Connect no more than three devices that support HDMI Link at the same time.
- If you have connected a speaker or receiver, set the output to PCM.

Parent topic: [Solving Projector or Remote Control Operation Problems](#)

Solutions When Wireless Authentication Fails

If you cannot authenticate a wireless connection, try the following solutions:

- Make sure the **Wireless LAN Power** setting is set to **On**.
- Check the Security settings and passphrase in the Network Configuration menu.
- Check the Event ID number displayed in the Info menu and check the link below to identify the problem.

Parent topic: [Solving Problems](#)

Related references

[Projector Feature Settings - Settings Menu](#)

[Projector Network Settings - Network Menu](#)

[Event ID Code List](#)

Where to Get Help

If you need to contact Epson for technical support services, use the following support options.

Internet Support

Visit Epson's support website at epson.com/support (U.S.), epson.ca/support (Canada), or epson.com.jm/support (Caribbean) and select your product for solutions to common problems with your projector. You can download utilities and documentation, get FAQs and troubleshooting advice, or e-mail Epson with your questions.

Speak to a Support Representative

To use the Epson PrivateLine Support service, call (800) 637-7661. This service is available for the duration of your warranty period. You may also speak with a projector support specialist by dialing (562) 276-4394 (U.S.) or (905) 709-3839 (Canada).

Support hours are 6 AM to 8 PM, Pacific Time, Monday through Friday and 7 AM to 4 PM, Pacific Time, Saturday.

Days and hours of support are subject to change without notice. Toll or long distance charges may apply.

Before you call, have the following information ready:

- Product name
- Product serial number (located on the bottom or rear of the projector, or in the menu system)
- Proof of purchase (such as a store receipt) and date of purchase
- Computer or video configuration
- Description of the problem

Purchase Supplies and Accessories

You can purchase screens, other optional accessories, and replacement parts from an Epson authorized reseller. To find the nearest reseller, call 800-GO-EPSON (800-463-7766) in the U.S. or 800-807-7766 in Canada. Or you can purchase online at epsonstore.com (U.S. sales) or epsonstore.ca (Canadian sales).

To purchase a replacement remote control, call (562) 276-4394 (U.S.) or (905) 709-3839 (for dealer referral in Canada).

Parent topic: [Solving Problems](#)

Technical Specifications

These sections list the technical specifications of your projector.

[General Projector Specifications](#)

[Projector Lamp Specifications](#)

[Remote Control Specifications](#)

[Projector Dimension Specifications](#)

[Projector Electrical Specifications](#)

[Projector Environmental Specifications](#)

[Projector Safety and Approvals Specifications](#)

[Supported Video Display Formats](#)

General Projector Specifications

Type of display	Poly-silicon TFT active matrix
Resolution	1920 × 1080 pixels (1080p)
Lens	F=2.0 to 3.0 Focal length: 22.5 to 46.7 mm
Color reproduction	Full color, up to 1 billion colors
Brightness	High Power Consumption mode: White light output 2400 lumens (ISO 21118 standard) Color light output 2400 lumens Note: Color brightness (color light output) and white brightness (white light output) will vary depending on usage conditions. Color light output measured in accordance with IDMS 15.4; white light output measured in accordance with ISO 21118.
Contrast ratio	200000:1 with Auto Iris on, Normal Power Consumption mode, Dynamic Color Mode, Wide Zoom mode, and Lens Shift Vertical: 10:0 and Horizontal: Centered
Image size (in native aspect ratio)	50 inches (1.27 m) to 300 inches (7.62 m)

Projection distance (in native aspect ratio)	58.3 inches (1.48 m) to 747.6 inches (18.99 m)
Projection methods	Front, rear, ceiling-mounted
Optical aspect ratio (width-to-height)	16:9
Focus adjustment	Powered
Zoom adjustment	Optical, powered
Zoom ratio (Tele-to-Wide)	1 to 2.1
Noise level	31 dB (High Power Consumption mode) 20 dB (ECO Power Consumption mode)
Keystone correction angle	± 30° vertical
USB Type B port compatibility	USB 1.1 and 2.0 compliant for service and firmware update
USB Type A port compatibility	Two USB 1.1 and 2.0 compliant ports; one for an Optical HDMI cable with 300mA power supply and the other for firmware update and Wi-Fi module with 500mA power supply

Parent topic: [Technical Specifications](#)

Projector Lamp Specifications

Type	UHE (Ultra High Efficiency)
Power consumption	250 W
Lamp life	High Power Consumption mode: Up to about 3500 hours Medium Power Consumption mode: Up to about 4000 hours ECO Power Consumption mode: Up to about 5000 hours

Note: Turn off this product when not in use to prolong the life of the projector. Lamp life will vary depending upon mode selected, environmental conditions, and usage. Brightness decreases over time.

Parent topic: [Technical Specifications](#)

Remote Control Specifications

Reception range	32 feet (10 m)
Batteries	Two alkaline or manganese AA

Parent topic: [Technical Specifications](#)

Projector Dimension Specifications

Height (excluding feet)	17.7 inches (450 mm)
Width	20.5 inches (520 mm)
Depth	6.7 inches (170 mm)
Weight	24.3 lb (11 kg)

Parent topic: [Technical Specifications](#)

Projector Electrical Specifications

Rated frequency	50/60 Hz
Power supply	100 to 240 VAC \pm 10% 3.8 to 1.7 A
Power consumption (100 to 120 V)	Operating: High Power Consumption mode: 373 W ECO Power Consumption mode: 283 W Standby: 0.3 W (Communication Off), 2 W (Communication On)

Power consumption

(220 to 240 V)

Operating:

High Power Consumption mode: 355 W

ECO Power Consumption mode: 271 W

Standby:

0.3 W (Communication Off), 2 W (Communication On)

Parent topic: [Technical Specifications](#)

Projector Environmental Specifications

Temperature

Operating: 41 to 95 °F (5 to 35 °C) (up to 4921 feet [1500 m])

Operating: 41 to 86 °F (5 to 30 °C) (above 4921 feet [1500 m])

Storage: 14 to 140 °F (–10 to 60 °C)

Humidity (relative, non-condensing)

Operating: 20 to 80%

Storage: 10 to 90%

Operating altitude

Up to 4921 feet (1500 m)

Up to 10000 feet (3048 m) with High Altitude Mode enabled

Parent topic: [Technical Specifications](#)

Projector Safety and Approvals Specifications

United States

FCC Part 15 Class B (DoC)

UL60950-1 2nd edition (cTUVus Mark)

Canada

ICES-003 Class B

CSA C22.2 No. 60950-1-07 (cTUVus Mark) / CSA C22.2 No. 62368-1-14 (cTUVus Mark)

Parent topic: [Technical Specifications](#)

Supported Video Display Formats

For best results, your computer's monitor port or video card resolution should be set to display in the projector's native resolution. However, your projector includes Epson's SizeWise chip that supports other computer display resolutions, so your image will be resized to fit automatically.

Your computer's monitor port or video card refresh rate (vertical frequency) must be compatible with the projector. (See your computer or video card manual for details.)

The table here lists the compatible refresh rate and resolution for each compatible video display format.

Display format	Refresh rate (in Hz)	Resolution (in pixels)
Computer signals (analog RGB)		
VGA	60	640 × 480
SVGA	60	800 × 600
XGA	60	1024 × 768
WXGA	60	1280 × 768
	60	1366 × 768
	60	1280 × 800
SXGA	60	1280 × 960
	60	1280 × 1024
WXGA++	60	1600 × 900
HDMI input signals		
VGA	60	640 × 480
SDTV (480i/480p)	60	720 × 480
SDTV (576i/576p)	50	720 × 576
HDTV (720p)	50/60	1280 × 720
HDTV (1080i)	50/60	1920 × 1080
HDTV (1080p)	24/30/50/60	1920 × 1080
4K × 2K	24/30/50/60	3840 × 2160
	24/50/60	4096 × 2160

HDMI 3D Signals

Display format	Refresh rate (in Hz)	Resolution (in pixels)	3D formats
HDTV (720p)	50/60	1280 × 720	Frame Packing Side by Side Top and Bottom
HDTV (1080i)	50/60	1920 × 1080	Side by Side
HDTV (1080p)	50/60	1920 × 1080	Side by Side
	24	1920 × 1080	Frame Packing Side by Side Top and Bottom

Compatible 4K HDR Signals

Display format (refresh rate)	Chroma subsampling (pixel encoding)	Color depth: 24 bits (8-bits per pixel)	Color depth: 30 bits (10-bits per pixel)	Color depth: 36 bits (12-bits per pixel)
4K/60p (60 Hz)	4:4:4	SDR	SDR	SDR
	4:2:2	SDR	SDR	SDR
	4:2:0	SDR	SDR	SDR
4K/24p (24 Hz)	4:4:4	SDR	SDR	SDR
	4:2:2	SDR	HDR	HDR ¹
	4:2:0	This signal does not exist.		

¹ This signal is processed at 4:2:2 10-bit.

Parent topic: [Technical Specifications](#)

Notices

Check these sections for important notices about your projector.

[Recycling](#)

[Important Safety Information](#)

[Important Safety Instructions](#)

[List of Safety Symbols](#)

[FCC Compliance Statement](#)

[Binding Arbitration and Class Waiver](#)

[Trademarks](#)

[Copyright Notice](#)

Recycling

Epson offers a recycling program for end of life products. Please go to [this site](#) for information on how to return your products for proper disposal.

Parent topic: [Notices](#)

Important Safety Information

Caution: Never look into the projector lens when the lamp is turned on; the bright light can damage your eyes. Never let children look into the lens when it is on. Never open any cover on the projector, except the lamp and filter covers. Dangerous electrical voltages inside the projector can severely injure you. Except as specifically explained in this *User's Guide*, do not attempt to service this product yourself. Refer all servicing to qualified service personnel.

Warning: The projector and its accessories come packaged in plastic bags. Keep plastic bags away from small children to avoid any risk of suffocation.

Caution: When you replace the lamp, never touch the new lamp with your bare hands; the invisible residue left by the oil on your hands may shorten the lamp life. Use a cloth or glove to handle the new lamp.

Parent topic: [Notices](#)

Important Safety Instructions

Follow these safety instructions when setting up and using the projector:

- Do not look into the lens when the projector is on. The bright light can damage your eyes. Avoid standing in front of the projector so the bright light does not shine into your eyes.
- Do not place the projector on an unstable cart, stand, or table.
- Do not operate the projector on its side, or while tilted to one side.
- If the projector is mounted on a ceiling or wall, it should be installed by qualified technicians using mounting hardware designed for use with this projector.
- When installing or adjusting a ceiling or wall mount, do not use adhesives to prevent the screws from loosening and do not use oils or lubricants. This may cause the projector case to crack and the projector to fall from its ceiling mount. This could cause serious injury to anyone under the mount and could damage the projector.
- Do not use the projector near water, sources of heat, high-voltage electrical wires, or sources of magnetic fields.
- Use the type of power source indicated on the projector. Use of a different power source may result in fire or electric shock. If you are not sure of the power available, consult your dealer or power company.
- Place the projector near a wall outlet where the plug can be easily unplugged.
- Take the following precautions when handling the plug: Do not hold the plug with wet hands. Do not insert the plug into a dusty outlet. Insert the plug firmly into the outlet. Do not pull the power cord when disconnecting the plug; always be sure to hold the plug when disconnecting it. Do not overload wall outlets, extension cords, or power strips. Failure to comply with these precautions could result in fire or electric shock.
- Do not place the projector where the cord can be walked on. This may result in fraying or damage to the plug.
- Unplug the projector from the wall outlet and allow to cool before cleaning. Use a dry cloth (or, for stubborn dirt or stains, a moist cloth that has been wrung dry) for cleaning. Do not use liquid or aerosol cleaners, any sprays containing flammable gas, or solvents such as alcohol, paint thinner, or benzene.
- Do not block the slots and openings in the projector case. They provide ventilation and prevent the projector from overheating. Do not operate the projector on a sofa, rug, or other soft surface, or set it on top of loose papers. Do not cover the projector with a blanket, curtain, or tablecloth. If you are setting up the projector near a wall, leave at least 7.9 inches (20 cm) of space between the wall and the projector.
- Do not operate the projector in a closed-in cabinet unless proper ventilation is provided.

- Never allow objects of any kind to enter any openings in the projector. Do not leave objects, especially flammable objects, near the projector. Never spill liquid of any kind into the projector.
- You may need to clean the air filter and vent. A clogged air filter or vent can block ventilation needed to cool the projector. Do not use canned air, or the gases may leave a residue.
- Do not store the projector outdoors for an extended length of time.
- Except as specifically explained in this manual, do not attempt to service this product yourself. Refer all servicing to qualified personnel. Opening or removing covers may expose you to dangerous voltages and other hazards.
- Never open any covers on the projector except as specifically explained in this manual. Never attempt to disassemble or modify the projector. Refer all repairs to qualified service personnel.
- Unplug the projector from the wall outlet and refer servicing to qualified service personnel under the following conditions: if it does not operate normally when you follow the operating instructions, or exhibits a distinct change in performance; if smoke, strange odors, or strange noises come from the projector; if the power cord or plug is damaged or frayed; if liquid or foreign objects get inside the projector, or if it has been exposed to rain or water; if it has been dropped or the housing has been damaged.
- Do not touch the plug during an electrical storm. Otherwise, you may receive an electric shock.
- Unplug the projector when it will not be used for extended periods.
- Do not use the projector where it may be exposed to rain, water, or excessive humidity.
- Do not use or store the projector where it may be exposed to smoke, steam, corrosive gases, excessive dust, vibration, or shock.
- Do not use the projector where flammable or explosive gases may be present.
- Do not use or store the projector or remote control in a hot location, such as near a heater, in direct sunlight, or in a closed vehicle.
- If you use the projector in a country other than where you purchased it, use the correct power cord for that country.
- Do not stand on the projector or place heavy objects on it.
- Do not use the projector outside of the required temperature range below:
41 to 95 °F (5 to 35 °C) at an altitude of 4921 feet (1500 m) or less, or 41 to 86 °F (5 to 30 °C) at a higher altitude
Doing so may cause an unstable display and could lead to projector damage. Do not use or store the projector where it may be exposed to sudden changes in temperature.

- Do not store the projector outside of the required temperature range of 14 to 140 °F (–10 to 60 °C) or in direct sunlight for long periods of time. Doing so may cause damage to the case.
- Do not place anything that can become warped or damaged by heat near the exhaust vents. Do not bring your hands or face close to the vents while projection is in progress. Do not bring your face close to the projector while it is in use.
- Before you move the projector, make sure its power is turned off, the plug is disconnected from the outlet, and all cables are disconnected.
- Do not disassemble the lamp or subject it to impacts.
- Do not place the source of an open flame, such as a lit candle, on or near the projector.
- Do not modify the power cord. Do not place heavy objects on top of the power cord or bend, twist, or pull it excessively. Keep the power cord away from hot electrical appliances.
- If the lamp breaks, ventilate the room to prevent gases contained in the lamp from being inhaled or coming in contact with your eyes or mouth. If you do inhale gases or gases come in contact with your eyes or mouth, seek medical advice immediately.
- If the projector is mounted overhead and the lamp breaks, be careful to prevent pieces of glass from falling into your eyes or mouth when you open the lamp cover. If pieces of glass do get into your eyes or mouth, seek medical advice immediately.

Note:  The lamp(s) in this product contain mercury. Please consult your state and local regulations regarding disposal or recycling. Do not put in the trash.

[Restriction of Use](#)

Parent topic: [Notices](#)

Restriction of Use







When this product is used for applications requiring high reliability/safety such as transportation devices related to aviation, rail, marine, automotive; disaster prevention devices; various safety devices; or functional/precision devices, you should use this product only after giving consideration to including fail-safes and redundancies into your design to maintain safety and total system reliability.







Because this product was not intended for use in applications requiring extremely high reliability/safety such as aerospace equipment, main communication equipment, nuclear power control equipment, or medical equipment related to direct medical care, please make your own judgment on this product's suitability after a full evaluation.









Parent topic: [Important Safety Instructions](#)







List of Safety Symbols

The following table lists the meaning of the safety symbols labeled on the equipment.

Symbol	Approved Standards	Description
	IEC60417 No.5007	"ON" (power) To indicate connection to the mains.
	IEC60417 No.5008	"OFF" (power) To indicate disconnection from the mains.
	IEC60417 No.5009	Stand-by To identify the switch or switch position by means of which part of the equipment is switched on in order to bring it into the stand-by condition.
	ISO7000 No.0434B, IEC3864-B3.1	Caution To identify general caution when using the product.
	IEC60417 No.5041	Caution, hot surface To indicate that the marked item can be hot and should not be touched without taking care.
	IEC60417 No.6042 ISO3864-B3.6	Caution, risk of electric shock To identify equipment that has risk of electric shock.
	IEC60417 No.5957	For indoor use only To identify electrical equipment designed primarily for indoor use.

Symbol	Approved Standards	Description
	IEC60417 No.5926	Polarity of DC power connector To identify the positive and negative connections (the polarity) on a piece of equipment to which a DC power supply may be connected.
	—	Polarity of DC power connector To identify the positive and negative connections (the polarity) on a piece of equipment to which a DC. power supply may be connected.
	IEC60417 No.5001B	Battery, general On battery powered equipment. To identify a device for instance a cover for the battery compartment, or the connector terminals.
	IEC60417 No.5002	Positioning of cell To identify the battery holder itself and to identify the positioning of the cell(s) inside the battery holder.
	—	Positioning of cell To identify the battery holder itself and to identify the positioning of the cell(s) inside the battery holder.
	IEC60417 No.5019	Protective earth To identify any terminal which is intended for connection to an external conductor for protection against electric shock in case of a fault, or the terminal of a protective earth electrode.
	IEC60417 No.5017	Earth To identify an earth (ground) terminal in cases where neither the symbol No.13 is explicitly required.

Symbol	Approved Standards	Description
	IEC60417 No.5032	Alternating current To indicate on the rating plate that the equipment is suitable for alternating current only; to identify relevant terminals.
	IEC60417 No.5031	Direct current To indicate on the rating plate that the equipment is suitable for direct current only; to identify relevant terminals.
	IEC60417 No.5172	Class II equipment To identify equipment meeting the safety requirements specified for Class II equipment according to IEC 61140.
	ISO 3864	General prohibition To identify actions or operations that are prohibited.
	ISO 3864	Contact prohibition To indicate injury that could occur due to touching a specific part of the equipment.
	—	Never look into the projector lens while the projector is on.
	—	To indicate that the marked item don't place anything on projector.
	ISO3864 IEC60825-1	Caution, laser radiation To indicate the equipment has a laser radiation part.

Symbol	Approved Standards	Description
	ISO 3864	Disassembly prohibition To indicate a risk of injury, such as electric shock, if the equipment is disassembled.
	IEC60417 No. 5266	Standby, partial standby To indicate that part of the equipment is in the ready status.
	ISO3864 IEC60417 No. 5057	Caution, movable parts To indicate that you must keep away from movable parts according to protection standards.
	IEC 60417-6056	Caution (movable fan blades) To indicate that you must keep away from movable parts according to protection standards.
	IEC 60417-6043	Caution (sharp corners) To indicate that you must not touch the sharp corners of the product according to protection standards.
	—	Never look into the projection lens while the projector is on.

Parent topic: [Notices](#)

FCC Compliance Statement

For United States Users

This equipment has been tested and found to comply with the limits for a Class B digital device, pursuant to Part 15 of the FCC Rules. These limits are designed to provide reasonable protection against harmful interference in a residential installation. This equipment generates, uses, and can radiate radio frequency energy and, if not installed and used in accordance with the instructions, may cause harmful interference to radio communications. However, there is no guarantee that interference will not occur in

a particular installation. If this equipment does cause interference to radio and television reception, which can be determined by turning the equipment off and on, the user is encouraged to try to correct the interference by one or more of the following measures:

- Reorient or relocate the receiving antenna.
- Increase the separation between the equipment and receiver.
- Connect the equipment into an outlet on a circuit different from that to which the receiver is connected.
- Consult the dealer or an experienced radio/TV technician for help.

This device complies with part 15 of the FCC Rules. Operation is subject to the following two conditions: (1) This device may not cause harmful interference, and (2) this device must accept any interference received, including interference that may cause undesired operation.

WARNING

The connection of a non-shielded equipment interface cable to this equipment will invalidate the FCC Certification or Declaration of this device and may cause interference levels which exceed the limits established by the FCC for this equipment. It is the responsibility of the user to obtain and use a shielded equipment interface cable with this device. If this equipment has more than one interface connector, do not leave cables connected to unused interfaces. Changes or modifications not expressly approved by the manufacturer could void the user's authority to operate the equipment.

For Canadian Users

CAN ICES-3(B)/NMB-3(B)

Parent topic: [Notices](#)

Binding Arbitration and Class Waiver

1. DISPUTES, BINDING INDIVIDUAL ARBITRATION, AND WAIVER OF CLASS ACTIONS AND CLASS ARBITRATIONS

1.1 Disputes. The terms of this Section 1 shall apply to all Disputes between you and Epson. The term "Dispute" is meant to have the broadest meaning permissible under law and includes any dispute, claim, controversy or action between you and Epson arising out of or relating to this Agreement, Epson branded products (hardware and including any related software), or other transaction involving you and Epson, whether in contract, warranty, misrepresentation, fraud, tort, intentional tort, statute, regulation, ordinance, or any other legal or equitable basis. "DISPUTE" DOES NOT INCLUDE IP CLAIMS, or more specifically, a claim or cause of action for (a) trademark infringement or dilution, (b) patent infringement, (c) copyright infringement or misuse, or (d) trade secret misappropriation (an "IP Claim"). You and Epson also agree, notwithstanding Section 1.6, that a court, not an arbitrator, may decide if a claim or cause of action is for an IP Claim.

1.2 Binding Arbitration. You and Epson agree that all Disputes shall be resolved by binding arbitration according to this Agreement. **ARBITRATION MEANS THAT YOU WAIVE YOUR RIGHT TO A JUDGE OR JURY IN A COURT PROCEEDING AND YOUR GROUNDS FOR APPEAL ARE LIMITED.**

Pursuant to this Agreement, binding arbitration shall be administered by JAMS, a nationally recognized arbitration authority, pursuant to its code of procedures then in effect for consumer related disputes, but excluding any rules that permit joinder or class actions in arbitration (for more detail on procedure, see Section 1.6 below). You and Epson understand and agree that (a) the Federal Arbitration Act (9 U.S.C. §1, et seq.) governs the interpretation and enforcement of this Section 1, (b) this Agreement memorializes a transaction in interstate commerce, and (c) this Section 1 shall survive termination of this Agreement.

1.3 Pre-Arbitration Steps and Notice. Before submitting a claim for arbitration, you and Epson agree to try, for sixty (60) days, to resolve any Dispute informally. If Epson and you do not reach an agreement to resolve the Dispute within the sixty (60) days, you or Epson may commence an arbitration. Notice to Epson must be addressed to: Epson America, Inc., ATTN: Legal Department, 3840 Kilroy Airport Way, Long Beach, CA 90806 (the "Epson Address"). The Dispute Notice to you will be sent to the most recent address Epson has in its records for you. For this reason, it is important to notify us if your address changes by emailing us at EAlegal@ea.epson.com or writing us at the Epson Address above. Notice of the Dispute shall include the sender's name, address and contact information, the facts giving rise to the Dispute, and the relief requested (the "Dispute Notice"). Following receipt of the Dispute Notice, Epson and you agree to act in good faith to resolve the Dispute before commencing arbitration.

1.4 Small Claims Court. Notwithstanding the foregoing, you may bring an individual action in the small claims court of your state or municipality if the action is within that court's jurisdiction and is pending only in that court.

1.5 WAIVER OF CLASS ACTIONS AND CLASS ARBITRATIONS. YOU AND EPSON AGREE THAT EACH PARTY MAY BRING DISPUTES AGAINST THE OTHER PARTY ONLY IN AN INDIVIDUAL CAPACITY, AND NOT AS A PLAINTIFF OR CLASS MEMBER IN ANY CLASS OR REPRESENTATIVE PROCEEDING, INCLUDING WITHOUT LIMITATION FEDERAL OR STATE CLASS ACTIONS, OR CLASS ARBITRATIONS. CLASS ACTION LAWSUITS, CLASS-WIDE ARBITRATIONS, PRIVATE ATTORNEY-GENERAL ACTIONS, AND ANY OTHER PROCEEDING WHERE SOMEONE ACTS IN A REPRESENTATIVE CAPACITY ARE NOT ALLOWED. ACCORDINGLY, UNDER THE ARBITRATION PROCEDURES OUTLINED IN THIS SECTION, AN ARBITRATOR SHALL NOT COMBINE OR CONSOLIDATE MORE THAN ONE PARTY'S CLAIMS WITHOUT THE WRITTEN CONSENT OF ALL AFFECTED PARTIES TO AN ARBITRATION PROCEEDING.

1.6 Arbitration Procedure. If you or Epson commences arbitration, the arbitration shall be governed by the rules of JAMS that are in effect when the arbitration is filed, excluding any rules that permit arbitration on a class or representative basis (the "JAMS Rules"), available at <http://www.jamsadr.com> or by calling 1-800-352-5267, and under the rules set forth in this Agreement. All Disputes shall be resolved by a single neutral arbitrator, and both parties shall have a reasonable opportunity to participate in the

selection of the arbitrator. The arbitrator is bound by the terms of this Agreement. The arbitrator, and not any federal, state or local court or agency, shall have exclusive authority to resolve all disputes arising out of or relating to the interpretation, applicability, enforceability or formation of this Agreement, including any claim that all or any part of this Agreement is void or voidable. Notwithstanding this broad delegation of authority to the arbitrator, a court may determine the limited question of whether a claim or cause of action is for an IP Claim, which is excluded from the definition of "Disputes" in Section 1.1 above. The arbitrator shall be empowered to grant whatever relief would be available in a court under law or in equity. The arbitrator may award you the same damages as a court could, and may award declaratory or injunctive relief only in favor of the individual party seeking relief and only to the extent necessary to provide relief warranted by that party's individual claim. In some instances, the costs of arbitration can exceed the costs of litigation and the right to discovery may be more limited in arbitration than in court. The arbitrator's award is binding and may be entered as a judgment in any court of competent jurisdiction.

You may choose to engage in arbitration hearings by telephone. Arbitration hearings not conducted by telephone shall take place in a location reasonably accessible from your primary residence, or in Orange County, California, at your option.

a) Initiation of Arbitration Proceeding. If either you or Epson decides to arbitrate a Dispute, both parties agree to the following procedure:

(i) Write a Demand for Arbitration. The demand must include a description of the Dispute and the amount of damages sought to be recovered. You can find a copy of a Demand for Arbitration at <http://www.jamsadr.com> ("Demand for Arbitration").

(ii) Send three copies of the Demand for Arbitration, plus the appropriate filing fee, to: JAMS, 500 North State College Blvd., Suite 600 Orange, CA 92868, U.S.A.

(iii) Send one copy of the Demand for Arbitration to the other party (same address as the Dispute Notice), or as otherwise agreed by the parties.

b) Hearing Format. During the arbitration, the amount of any settlement offer made shall not be disclosed to the arbitrator until after the arbitrator determines the amount, if any, to which you or Epson is entitled. The discovery or exchange of non-privileged information relevant to the Dispute may be allowed during the arbitration.

c) Arbitration Fees. Epson shall pay, or (if applicable) reimburse you for, all JAMS filings and arbitrator fees for any arbitration commenced (by you or Epson) pursuant to provisions of this Agreement.

d) Award in Your Favor. For Disputes in which you or Epson seeks \$75,000 or less in damages exclusive of attorney's fees and costs, if the arbitrator's decision results in an award to you in an amount greater than Epson's last written offer, if any, to settle the Dispute, Epson will: (i) pay you \$1,000 or the amount of the award, whichever is greater; (ii) pay you twice the amount of your reasonable attorney's fees, if any; and (iii) reimburse you for any expenses (including expert witness fees and costs) that your attorney reasonably accrues for investigating, preparing, and pursuing the Dispute in arbitration. Except as

agreed upon by you and Epson in writing, the arbitrator shall determine the amount of fees, costs, and expenses to be paid by Epson pursuant to this Section 1.6d).

e) Attorney's Fees. Epson will not seek its attorney's fees and expenses for any arbitration commenced involving a Dispute under this Agreement. Your right to attorney's fees and expenses under Section 1.6d) above does not limit your rights to attorney's fees and expenses under applicable law; notwithstanding the foregoing, the arbitrator may not award duplicative awards of attorney's fees and expenses.

1.7 Opt-out. You may elect to opt-out (exclude yourself) from the final, binding, individual arbitration procedure and waiver of class and representative proceedings specified in this Agreement by sending a written letter to the Epson Address within thirty (30) days of your assent to this Agreement (including without limitation the purchase, download, installation of the Software or other applicable use of Epson Hardware, products and services) that specifies (i) your name, (ii) your mailing address, and (iii) your request to be excluded from the final, binding individual arbitration procedure and waiver of class and representative proceedings specified in this Section 1. In the event that you opt-out consistent with the procedure set forth above, all other terms shall continue to apply, including the requirement to provide notice prior to litigation.

1.8 Amendments to Section 1. Notwithstanding any provision in this Agreement to the contrary, you and Epson agree that if Epson makes any future amendments to the dispute resolution procedure and class action waiver provisions (other than a change to Epson's address) in this Agreement, Epson will obtain your affirmative assent to the applicable amendment. If you do not affirmatively assent to the applicable amendment, you are agreeing that you will arbitrate any Dispute between the parties in accordance with the language of this Section 1 (or resolve disputes as provided for in Section 1.7, if you timely elected to opt-out when you first assented to this Agreement).

1.9 Severability. If any provision in this Section 1 is found to be unenforceable, that provision shall be severed with the remainder of this Agreement remaining in full force and effect. **The foregoing shall not apply to the prohibition against class or representative actions as provided in Section 1.5. This means that if Section 1.5 is found to be unenforceable, the entire Section 1 (but only Section 1) shall be null and void.**

Parent topic: [Notices](#)

Trademarks

EPSON® is a registered trademark and EPSON Exceed Your Vision is a registered logomark of Seiko Epson Corporation.

PrivateLine® is a registered trademark and Extra CareSM is a service mark of Epson America, Inc.

Mac is a trademark of Apple Inc., registered in the U.S. and other countries.

Windows is a registered trademark of Microsoft Corporation in the United States and/or other countries.

Google® is a registered trademark and Android™ is a trademark of Google LLC.

HDMI and High-Definition Multimedia Interface are the trademarks or registered trademarks of HDMI Licensing LLC.  HIGH DEFINITION MULTIMEDIA INTERFACE

General Notice: Other product names used herein are for identification purposes only and may be trademarks of their respective owners. Epson disclaims any and all rights in those marks.



Parent topic: [Notices](#)

Copyright Notice

All rights reserved. No part of this publication may be reproduced, stored in a retrieval system, or transmitted in any form or by any means, electronic, mechanical, photocopying, recording, or otherwise, without the prior written permission of Seiko Epson Corporation. The information contained herein is designed only for use with this Epson product. Epson is not responsible for any use of this information as applied to other products.

Neither Seiko Epson Corporation nor its affiliates shall be liable to the purchaser of this product or third parties for damages, losses, costs, or expenses incurred by purchaser or third parties as a result of: accident, misuse, or abuse of this product or unauthorized modifications, repairs, or alterations to this product, or (excluding the U.S.) failure to strictly comply with Seiko Epson Corporation's operating and maintenance instructions.

Seiko Epson Corporation shall not be liable for any damages or problems arising from the use of any options or any consumable products other than those designated as Original Epson Products or Epson Approved Products by Seiko Epson Corporation.

This information is subject to change without notice.

[A Note Concerning Responsible Use of Copyrighted Materials](#)
[Copyright Attribution](#)

Parent topic: [Notices](#)

A Note Concerning Responsible Use of Copyrighted Materials

Epson encourages each user to be responsible and respectful of the copyright laws when using any Epson product. While some countries' laws permit limited copying or reuse of copyrighted material in

certain circumstances, those circumstances may not be as broad as some people assume. Contact your legal advisor for any questions regarding copyright law.

Parent topic: [Copyright Notice](#)

Copyright Attribution

© 2018 Epson America, Inc.

8/18

CPD-55708

Parent topic: [Copyright Notice](#)