

Leisure 410

User Manual

Contents

Notice.....	3
Introduction to your projector.....	3
Product Packing List.....	3
Projector Overview.....	4
Projector Specification.....	5
Setting up Your Projector.....	6
Projector Installation Options.....	6
Projection Distance and Size.....	7
Projector Connections.....	8
Connecting to the External Storage Device.....	9
Playing the Video.....	10
Playing the Music.....	13
Playing the Photo.....	17
Playing the Text.....	20
Connecting to the Computer.....	23
Connecting to the Mobile Device.....	26
Connecting to the DVD Player.....	28
Using the Basic Projector Features.....	29
TV Settings.....	29
Picture Settings.....	30
Sound Settings.....	32
Sleep Timer Settings.....	33
Option Settings.....	34
After Using Your Projector.....	35
Troubleshooting.....	36

Notice

1. Please read this manual thoroughly before using the projector;
2. Please use the correct power cord for the country where you are located;
3. Do not look into the lens when the projector is on to prevent the bright light from hurting your eyes;
4. Do not place the projector on an unstable stand, or table;
5. Do not use the projector where it may be exposed to rain, water, or excessive humidity;
6. If you do not use the projector for a long time, make sure its power is turned off and the plug is disconnected from the outlet;
7. When shipping the projector, place it in its original packing materials or use equivalent materials with cushioning around the projector;
8. If the projector is mounted on a ceiling or wall, it should be installed by the safe mounting hardware;
9. If the projector is damaged, do not attempt to service this product yourself and contact Vankyo Support Team;

Introduction to your projector

Product Packing List

Please keep all the packaging material in case shipment is needed in the future. Make sure you receive all the parts below.

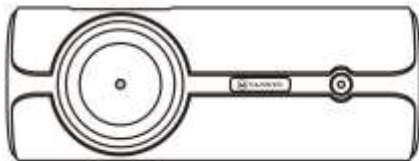

Leisure 410



Carrying Bag



Remote



User Manual



AV cable



HDMI cable



Power cable

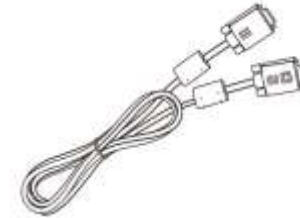

VGA cable

If there is any part missing, please contact Vankyo Support Team.

Projector Overview

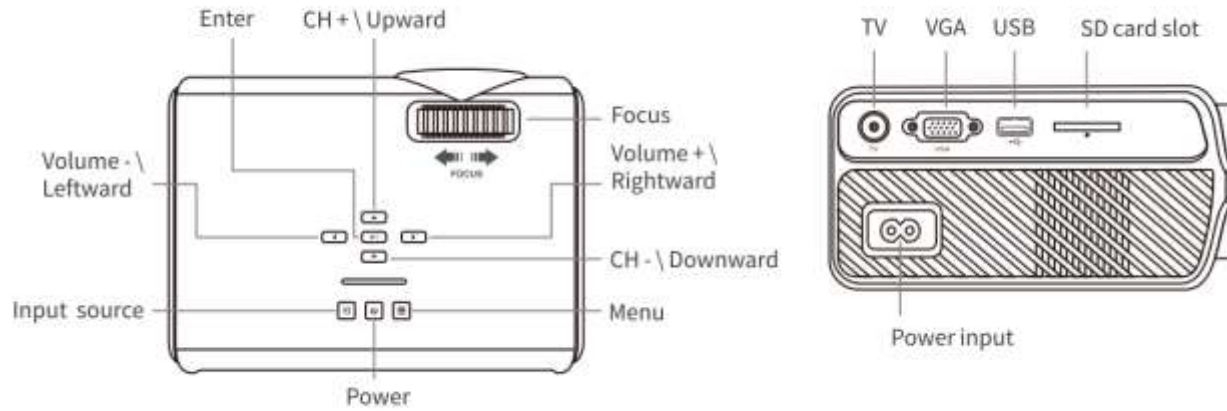

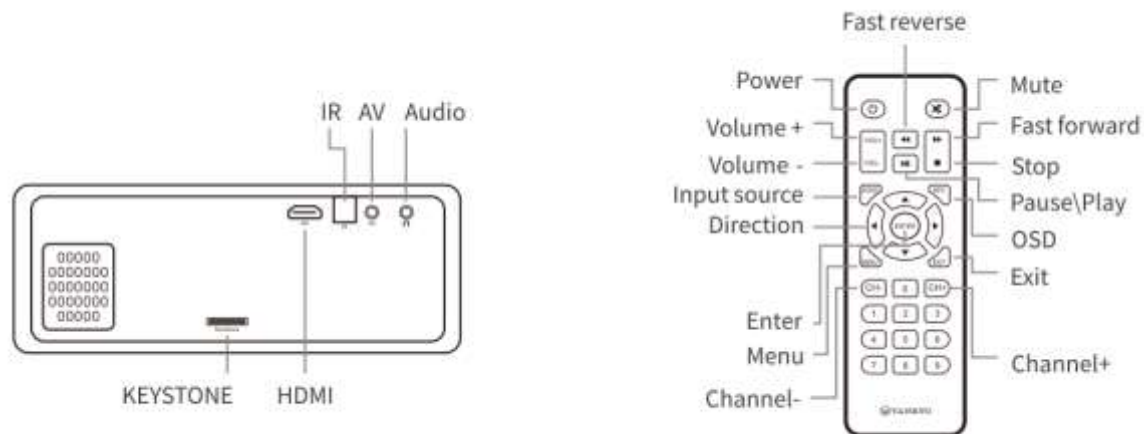

Projector Specification

Projector Type	Video Projector	Projection Screen	33-170 inches
Display Technology	LCD	Keystone	±15°
Light Source	LED	Power Voltage	AC~ 100V-240V 50Hz\60Hz
Remote	Yes	Projection Method	Front\Rear\Ceiling
Lamp Life	40000 Hours	Aspect Ratio	4:3\16:9\ auto
Display Colors	16.7M	Focus	Manual Operation
Native Resolution	800*480	SD card Maximum Support	SD2.0\SDHC Support 32G
Supported Resolution	480p\720p\1080p	Hard disk Maximum Support	1024G, need external power supply
Contrast	2000:1	Built-in Speaker	2W/4ohm
Projection Distance	1.12-6m	HDMI/VGA/AV	480p\480i\576p\576i\720p\720i\1080p\1080i
Power Supply	100V-240V	Audio File	MP3\WMA\M4A\AAC\WAV
Text File	Text	Picture File	BMP\JPG\PNG
Video file	MPG\MPE\VOB\TS\RM\RMVB\AVI\MP4\DIV\MOV\MKV\ASF\FLV\WMV\3GP\3G2		
Port	AV*1\VGA*1\USB*1\SD*1\HDMI*1\ATV*1\Audio Out*1		

Setting up Your Projector

Projector Installation Options

Depending on how you positioned the projector, you may need to change the projection direction to project your images correctly. If you project from the ceiling or from the rear, please go to **Menu—Picture—Projection Direction** to set up the projection modes. There are following modes for different installing options.



1. **Front**, in this mode, the projector must be placed in front of the wall/screen, and image will be directly projected to the wall/screen.

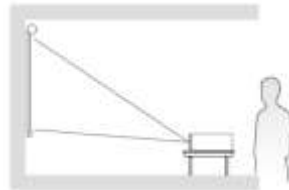

2. **Rear on desk**, in this mode, the projector can be placed behind the screen and a compatible screen which supports rear projector will be required.

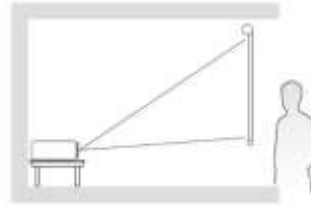

3. **Front On Ceiling**, which flips the image over top-to-bottom to project upside-down from a ceiling or wall mount.

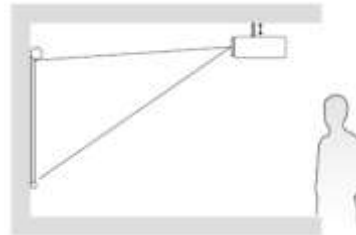

4. **Rear On Ceiling**, in this mode, the projector is placed behind the screen with the lens upside down. This mode allows you to flip the image over. A compatible screen which supports rear projector will be required.

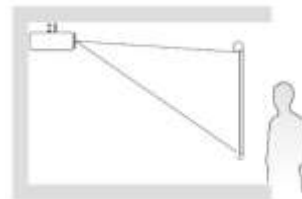

Note:

Wherever you set up the projector, make sure to position it squarely in front of the center of the screen or the wall.

Projection Distance and Size

The distance at which you place the projector from the screen determines the approximate size of the image. The projection size increases when the projector is farther from the screen.

Locate the projector at an appropriate position, then adjust the focus ring and Keystone (**on the back side of the projector**) manually to get the best image performance.

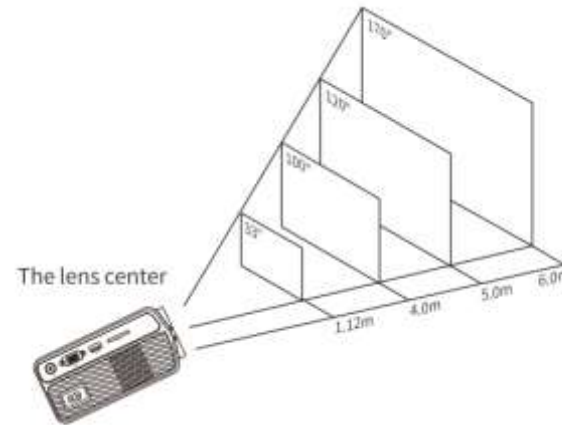

Note:

Being too far or too close between the projector and the wall/screen, or the incorrect adjustment of the focus ring and Keystone may result in the poor image.

Projector Connections

When you connect any device to the projector, please follow the steps below at your first use of the projector.

Step 1: Connect the power cord into the projector's power inlet, then plug the power cord into an electrical outlet;

Step 2: Take off the lens cover, then press the **Power** button on the projector or the remote to turn on the projector;

Step 3: Enter the interface of the **OSD Language** to set your preferred language;

Step 4: Press the **Up/Down/Left/Right** buttons to select your language, then press the **OK/Enter** button of the projector/remote to confirm;

Step 5: It will show a screen with **No Signal**. Insert the device/cables into the correspondingly ports on the projector;

Step 6: Press the  button on the projector or the **Source** button on the remote to enter the interface of **Input Source**;

Step 7: Press the **Up/Down** or the **Source** button, then press the **OK/Enter** button to select the correct input source.

Step 8: Adjust the focus ring and keystone (**on the back side of the projector**) to get the best image performance.

Tips:

1. After you plug the power cord into the inlet, turn on the projector until the LED indicator on the projector shows solid **Red**. If the projector is turned on and working properly, the LED indicator shows solid **Blue**.
2. Never look into the projector lens when the lamp is on. This can damage your eyes and is especially dangerous for children;
3. Install 2 pieces of AAA batteries into the remote before using it.

Connecting to the External Storage Device

You can project movies, music, photos, and texts by connecting USB Drive, SD Card, Hard Disk (extra power supply is required) to your projector even without using a computer or a mobile device.

Step 1: After connecting the different external devices, press the  button on the projector or the **Source** button on the remote to enter the interface of **Input Source**.

Step 2: Press the **Up/Down/Source** on the projector or remote to select the correct input source, then press the **OK/Enter** button of the projector/remote to confirm. For USB/Hard Disk or SD card, please select input source **USB/SD**;

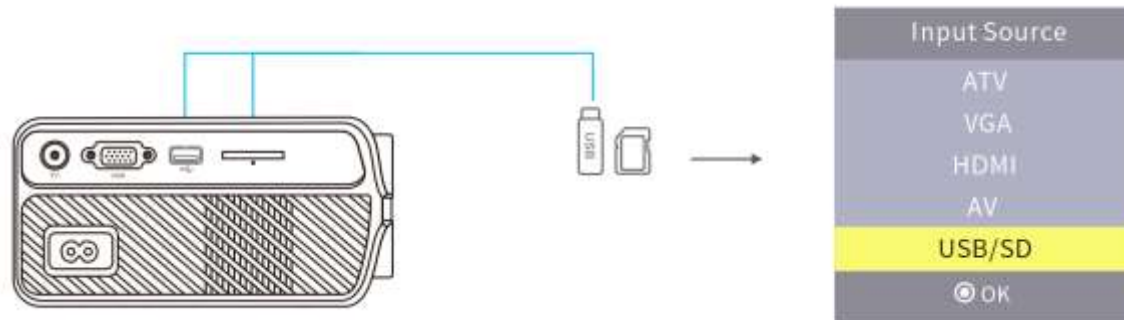

Playing the Video

After selecting **USB/SD** in the interface of **Input Source**, you will enter the main interface which shows the options of **Movie**, **Music**, **Photo**, **Text** and **Support**.

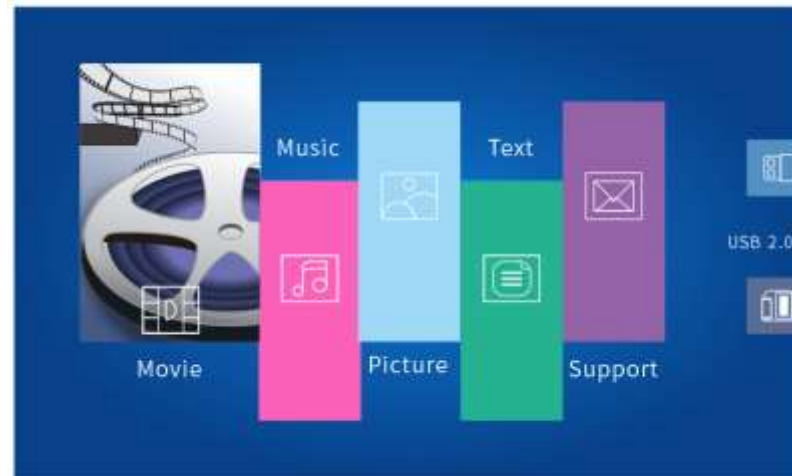

Step 1: Select **Movie** in the main interface by pressing the **Left/Right** buttons, the selected frame will show a picture, then press the **OK/ Enter** button on the projector/remote to enter the following interface;



Step 2: Select the disk **C**, then press the **OK/Enter** button on the projector/remote to enter the disk;

Step 3: Select the video file or click the folder to enter the next directory till you find the video you would like to play in the directory;



Step 4: Press the **OK** button on the projector or the **Play/Pause** button on the remote to play the video into full-screen mode.



Tips:

1. Select the **Return** icon and press the OK/Enter button to return to the root directory shown in **Step 1** no matter in which directory, while select the **Up Folder** icon and press the **OK** button to return to the parent directory;
2. Hover on the selected video for more than 3 seconds to preview the video, press the **OK** button on the projector or the **Play/Pause** button on the remote to play the video.
3. The selected icon will be marked as **Orange**.

Press the **UP/Enter** button when playing the video, it will show a bottom bar with different settings. Press the **Down** button or the **Menu** button on the projector, the **Down** Button or the **Exit** button on the remote to hide it.



Play/Pause: plays or pauses the current video;

FB: Fast Backward, rewinds the video back quickly while playing it. The rewinding speed ranges from 2 X to 32X;

FF: Fast Forward, pushes the video to move forward quickly while playing it. The forward speed ranges from 2 X to 32X;

Prev.: Previous, goes back to the previous video;

Next: goes to the next video;

Stop: exits from the current video;

All: has the options of **All**, **None** and **One**. Press the **OK/Enter** button to switch among these options. **All** loops to play all the videos in your playlist; **None** plays the current video once,

then exits from the current video; **One** loops to play the current video all the time;

Set A/Set B/None: selects **Set A** by pressing the **OK/Enter** button to set a time point and select **Set B** by pressing **OK/Enter** button to set another time point when playing the video, then it will loop to play the video fragment between these points. Select **None** to return to normal playing mode;

Playlist: a list of video files that can be played from the current folder. If you did not tick the favorite videos by pressing the **OK/Enter** button in the directory, it will show all the video files in this folder that can be played; otherwise, it will only show your ticked video(s);

Info: shows the information about the current video including resolution, size, and so on;

Slow...: Slow Forward, plays the video in slow motion with a speed being range from 2X to 16X;

Step...: Step Forward, steps forward the video frame by frame by pressing the **OK/Enter** button;

Goto...: inputs the time by pressing the numbers on the remote to directly skip to the set time point;

Zoom I: zooms in the image size from 1X to 8X;

Zoom O: zooms out the image size to 1/2 or 1/4;

Aspect: sets the aspect ratio as **Auto, 4:3** and **16:9**.

Tips:

1. Your projector can play videos with formats of MPG/MPE/VOB/TS/RM/RMVB/AVI/MP4/DIV/MOV/MKV/ASF/FLV/WMV/3GP/3G2.
2. All the folders will be shown in the USB disk or SD card, but you can only play the video files after you select **Movie** in the main interface.

Playing the Music

After selecting **USB/SD** in the interface of **Input Source**, you will enter the main interface which shows the options of **Movie, Music, Photo, Text** and **Support**.

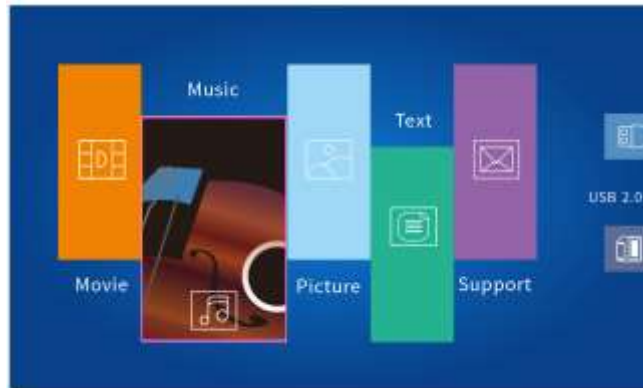

Step 1: Select **Music** in the main interface by pressing the **Left/Right** buttons, the selected frame will show a picture, then press the **OK/ Enter** button on the projector/remote to enter the following interface;



Step 2: Select the disk **C**, then press the **OK/Enter** button on the projector/remote to enter the disk;

Step 3: Select the music file or click the folder to enter the next directory till you find the music you would like to play in the directory;



Step 4: Press the **OK** button on the projector or the **Play/Pause** button on the remote to play the music.

Tips:

1. Select the **Return** icon and press the **OK/Enter** to return to the root directory shown in **Step 1** no matter in which directory, while select the **Up Folder** icon and press the **OK** button to return to the parent directory;
2. Hover on the selected music for more than 3 seconds to preview the music, press the **OK** button on the projector or the **Play/Pause** button on the remote to play the music.
3. The selected icon will be marked as **Orange**.

It will show a bottom bar with different settings when playing the music. Press the **Down** button or the **Menu** button on the projector, the **Down** Button or the **Exit** button on the remote to hide the bottom bar and into the **full-screen mode**. Press the **UP/Enter** button to show the bottom bar again.

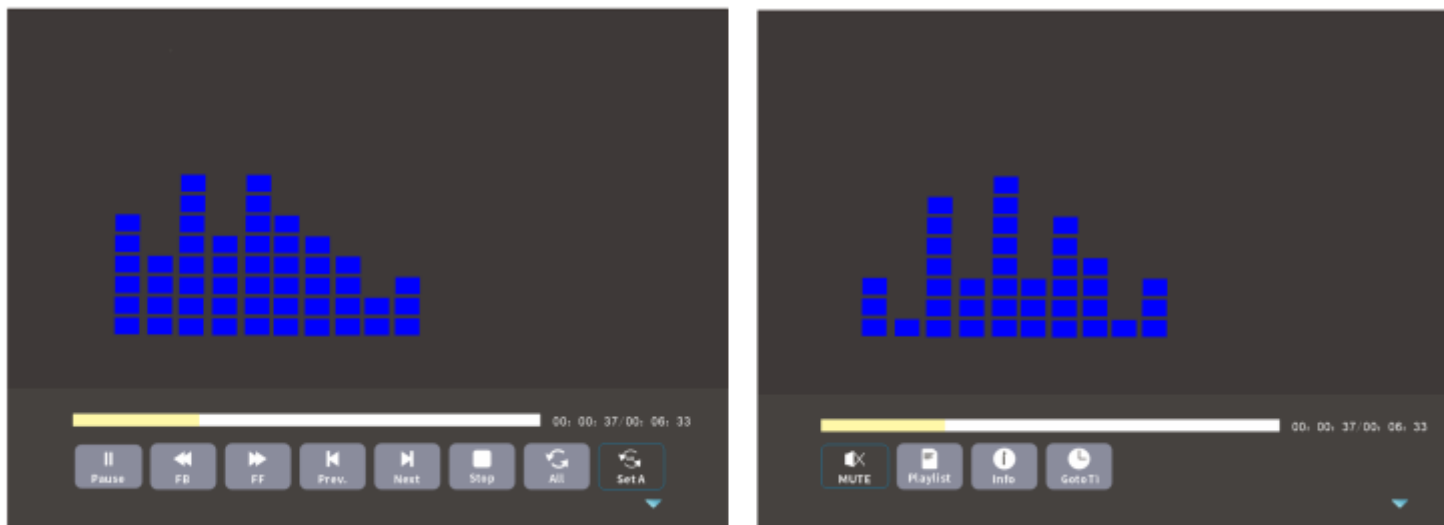

Play/Pause: plays or pauses the current music by pressing the **OK/Enter** button;

FB: Fast Backward, rewinds the music back quickly while playing it. The rewinding speed ranges from 2 X to 16X;

FF: Fast Forward, pushes the music to move forward quickly while playing it. The forward speed ranges from 2 X to 16X;

Prev.: Previous, goes back to the previous music;

Next: goes to the next music;

Stop: exits from the current music;

All/None/One: has the options of **All**, **None** and **One**. Press the **OK/Enter** button to switch among these options. **All** loops to play all the music in your playlist; **None** plays the current music once, then exits from the current music; **One** loops to play the current music all the time;

Set A/Set B/None: selects **Set A** by pressing the **OK/Enter** button to set a time point and select **Set B** by pressing the **OK/Enter** button to set another time point, then it will loop to play the music fragment between these points. Select **None** to get back to the normal playing mode;

Mute: mutes or unmutes the current music by pressing the **OK/Enter** button;

Playlist: a list of music files that can be played from the current folder. If you did not tick the favorite music by pressing the **OK/Enter** button in the directory, it will show all the music files in this folder that can be played; otherwise, it will show your ticked music file(s);

Info: shows the information about the current music including Bit Rate, Artist, Size, and so on.

Goto...: inputs the time by pressing the numbers on the remote to directly skip to the set time point.

Tips:

1. Your projector can play the audio files with formats of MP3/WMA/M4A/AAC/WAV.
2. All the folders will be shown in the USB disk or SD card, but you can only play the music files after you select **Music** in the main interface.

Playing the Photo

After selecting **USB/SD** in the interface of **Input Source**, you will enter the main interface which shows the options of **Movie**, **Music**, **Photo**, **Text** and **Support**.

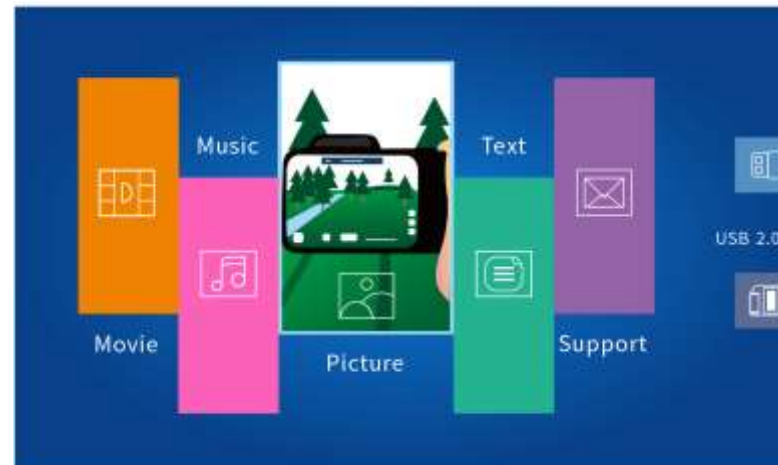

Step 1: Select **Photo** in the main interface by pressing the **Left/Right** buttons, the selected frame will show a picture, the press the **OK/ Enter** button on the projector/remote to enter the following interface;



Step 2: Select the disk **C**, then press the **OK/Enter** button on the projector/remote to enter the disk;

Step 3: Select the music file or click the folder to enter the next directory till you find the music you would like to play in the directory;



Step 4: Press the **OK** button on the projector or the **Play/Pause** button on the remote to play the photo.

Tips:

1. Select the **Return** icon and press the **OK/Enter** button to return to the root directory shown in **Step 1** no matter in which directory, while select the **Up Folder** icon and press the **OK** button to return to the parent directory;
2. Hover on the selected photo for more than 3 seconds to preview the photo, press the **OK** button on the projector or the **Play/Pause** button on the remote to play the photo.
3. The selected icon will be marked as **Orange**.

It will show a bottom bar with different settings when playing the photo. Press the **Down** button or the **Menu** button on the projector, the **Down** Button or the **Exit** button on the remote to hide the bottom bar and into a full-screen mode. Press the **OK** button on the remote to show the bottom bar again.



Play/Pause: plays or pauses the current photo by pressing the **OK/Enter** button;

Prev.: Previous, goes back to the previous photo;

Next: goes to the next photo;

Stop: exits from the current photo;

All/None/One: has the options of **All**, **None** and **One**. Press the **OK/Enter** button to switch among these options. **All** loops to play all the photos in your playlist; **None** plays the current photo once, then exits from the current music; **One** loops to play the current photo all the time;

Music: after you tick some music file(s) under the **Music** category by pressing the **Enter** button on the remote, then go to the **Photo** category. Press the **OK/Enter** button when selecting the **Music** icon from the bottom bar, it will play the music file(s) you ticked for photo background;

Playlist: a list of photo files that can be played from the folder. If you did not tick the favorite photos by pressing the **Enter** button on the remote in the Sub-menu, it will show all the photos in this folder that can be played; otherwise, it will show your ticked photo(s).

Info.: shows the information about the current photo including resolution, size, date and time;

: rotates the photo by 90 degrees clockwise;

: rotates the photo by 90 degrees counterclockwise;

: zooms in the photo size from 1X to 8X;

: zooms out the photo size to 1/2 and 1/4;

Move: after zooming in the photo, press the **OK/Enter** button when selecting the **Move** icon. You can view more details of the current photo by pressing the **Up/Down/Left/Right** buttons;

Slide S: Slide Show, the animation modes for switching the photos. There are options of **Fade**, **Normal**, **Random**, **Blocks**, **Diagonal B**, **Wipe** and **Slide**.

Tips:

1. Your projector can play the photo with formats of BMP/JPG/PNG.
2. All the folders will be shown in the USB disk or SD card, but you can only play the photo after you select **Photo** in the main interface.

Playing the Text

Step 1: Select **Photo** in the main interface by pressing the **Left/Right** buttons, the selected frame will show a picture, the press the **OK/ Enter** button on the projector/remote to enter the following interface;

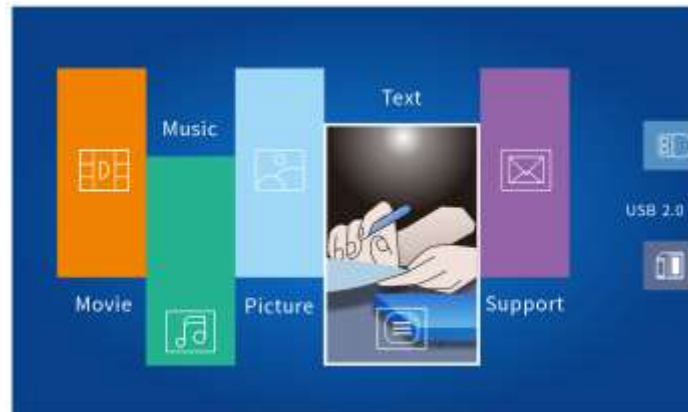

Step 2: Select the disk **C**, then press the **OK/Enter** button on the projector/remote to enter the disk;



Step 3: Select the music file or click the folder to enter the next directory till you find the music you would like to play in the directory;



Step 4: Press the **OK** button on the projector or the **Play/Pause** button on the remote to play the photo.

Press the **Up/Enter** button on the remote when playing the text, it will show a bottom bar with different settings. Press the **Down** button or the **Menu** button on the projector, the **Down** Button or the **Exit** button on the remote to hide the bottom bar and into a full-screen mode.

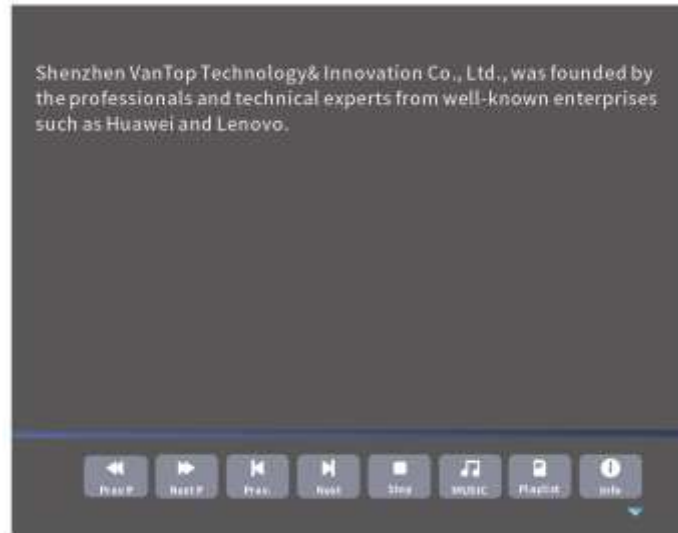

Prev P: Previous Page, goes back to the previous page of the current text;

Next P: Next Page, goes to the next page of the current text;

Prev.: Previous, goes back to the previous text;

Next: goes to the next text;

Stop: exits from the current text;

Music: after you tick some music files under the **Music** category by pressing the **Enter** button on the remote, go to the **TEXT** category. Press the **OK/Enter** button when selecting the **Music** icon from bottom bar, it will play the music file(s) you ticked for text background;

Playlist: a list of text files that can be played from the folder. If you did not tick the texts by pressing the **Enter** button on the remote in the Sub Menu, it will show all the texts that can be played; otherwise, it will show your ticked text(s).

Info.: shows the size of the current text;

Tips:

1. Select the **Return** icon and press the **OK/Enter** button to return to the root directory shown in **Step 1** no matter in which directory, while select the **Up Folder** icon and press the

- OK** button to return to the parent directory;
- 2. All the folders will be shown in the USB disk or SD card, but you can only play the text after you select **TEXT** in the main interface.
- 3. Your projector can play the text files with a format of TXT.
- 4. The selected icon will be marked as **Orange**.

Connecting to the Computer

When you're in a conference room and need to project slides, videos, music and so on, please connect your computer to the projector.

Option 1: Connect the projector to your computer by using the HDMI cable in the package. An HDMI connection is recommended for projecting movies, videos, and other files which need to be HD.

Step 1: Turn on your computer and the projector;

Step 2: Connect the HDMI cable to your computer's HDMI port;

Step 3: Connect the other end to any available HDMI port on your projector;

Step 4: Press the  button on the projector or the **Source** button on the remote to enter the interface of **Input Source**;

Step 5: Select **HDMI** to project any files on your computer by pressing the **Up/Down** or the **Source** button on the projector or the remote.

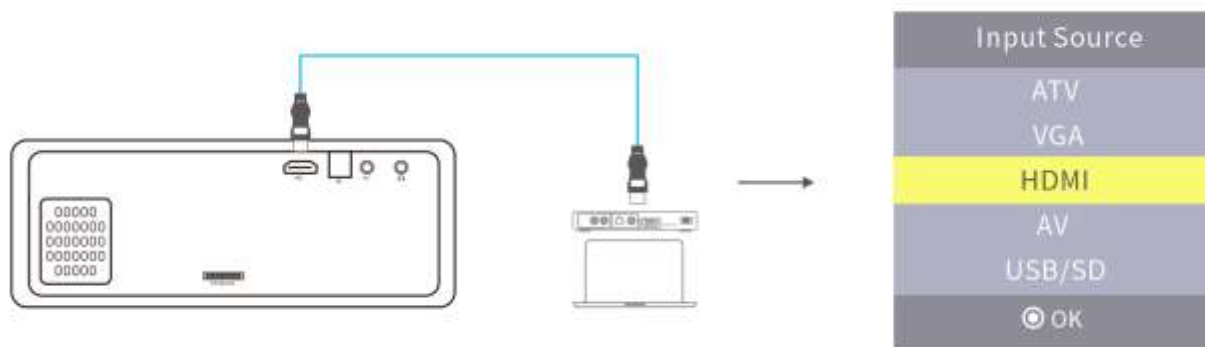

Step 6: Press the corresponding keys on the keyboard to invoke a display-switch toolbar with various display options like **PC Screen only**, **Duplicate**, **Extend** and **Second screen only**.

Option 2: You can also connect the projector to your computer by using a VGA computer cable in the package.

Step 1: Turn on your computer and the projector;

Step 2: Connect the VGA cable to your computer's VGA port;

Step 3: Connect the other end to the VGA port on your projector;

Step 4: Press the  button on the projector or the **Source** button on the remote to enter the interface of **Input Source**;

Step 5: Select **VGA** to project any file on your computer by pressing the **Up/Down** or the **Source** button on the projector or the remote, then press the **OK/Enter** button.

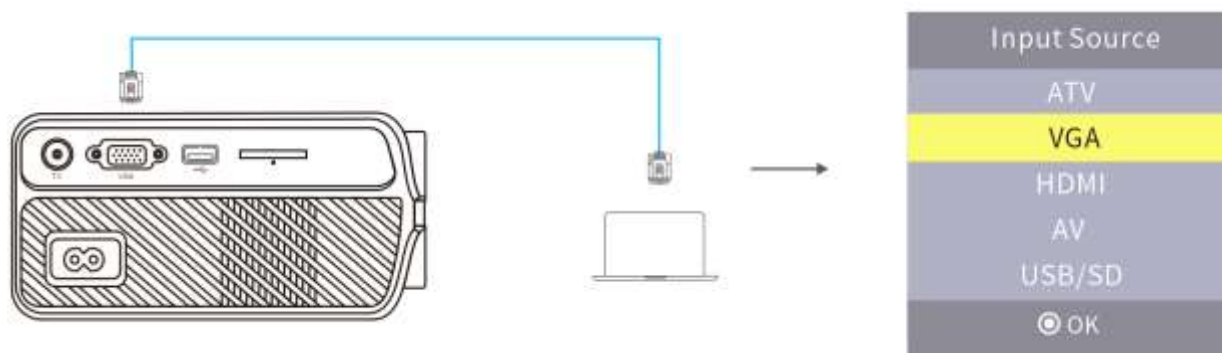

Step 6: Press the corresponding keys on the keyboard to invoke a display-switch toolbar with various display options like **PC Screen only**, **Duplicate**, **Extend** and **Second screen only**.

Notes:

1. To connect a **Mac/Surface** that includes only a Mini DisplayPort, Thunderbolt port, or Mini-DVI port, you need to obtain an adapter that allows you to connect to the projector's HDMI or VGA port. Contact **Apple/Microsoft** for compatible adapter or get from any store by yourself. For example, here is a Mini DP cable which can be used as a reference (insert on end of the HDMI cable in the package to the projector and the other end to the HDMI connector of the Mini DP port when using):

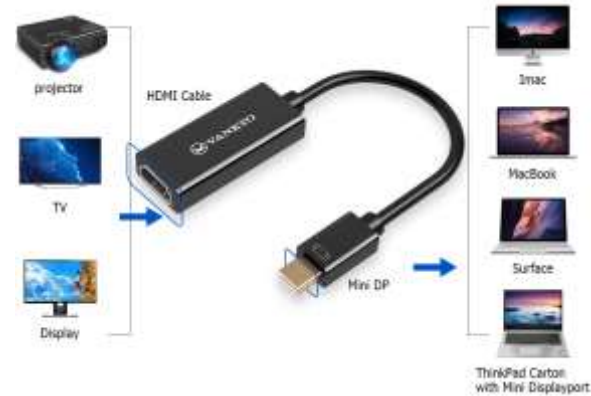

2. You need to select the project option when connecting your computer to the projector at the first use no matter you connected by HDMI or VGA option.
- For **Windows7** and **higher** system, pressing the **Windows logo key + P** key at the same time invokes a display-switch toolbar with various display options shown below:

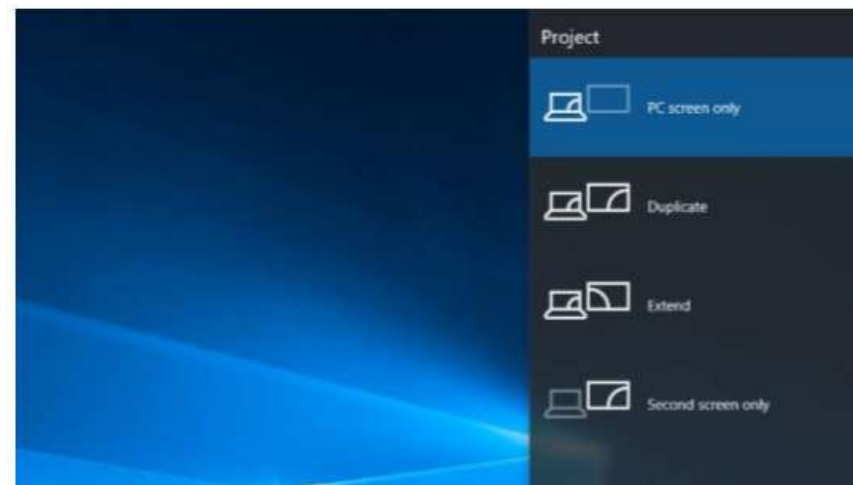

PC screen only -This option displays the contents of your computer screen on the computer only. This is a great option to choose when your presentation hasn't yet started or if you want to use the computer for another reason and don't want the contents of the screen displayed through the projector for all to see.

Duplicate - This option simultaneously displays the contents of the computer screen on the computer screen and through the projector. This is a great choice when your back will be toward the projector's screen while giving a presentation. This way you can watch the computer screen while the audience watches the projector screen and you won't have to continually turn your back to the audience during the presentation.

Extend - This option splits the image between the computer and projector. This way you can display one thing on your computer screen and something else on the projector screen. This is great when using PowerPoint so the presentation is displayed on the projector while your presentation notes are displayed on your computer screen in front of you.

Projector Only (Second Screen Only) - As its name implies, this option will display the content of your presentation on the projector, but show a blank screen on your computer. Although not a popular choice, this is a good option when you are running your presentation from your laptop on battery power. Turning off the laptop screen can help preserve battery life.

Combination keys to invoke and switch the display mode might vary depending on different computer brands or models. Link with detailed information:

<http://kb.mcgill.ca/?portalid=2&articleid=1750#tab:homeTab:crumb:8:artId:1751:src:article>

- For **the Windows XP** system, please refer to <https://www.youtube.com/watch?v=fV6PQu1VzFg>
- For the **Mac** system, Choose **Apple** menu > **System Preferences**, click **Displays**, then select the **Arrangement** tab to check/uncheck the **Mirror Display** box to extend or mirror the content to the projection screen. For more information, please refer to <https://support.apple.com/en-us/HT202351>;

Connecting to the Mobile Device

If you would like to project the files on your mobile devices like the smartphone or tablet, you can connect the projector to them.

Step 1: Turn on your mobile device and the projector;

Step 2: According to the connector on your mobile device, prepare an HDMI adapter by yourself;

Step 3: Connect the HDMI port to your projector;

Step 4: Connect the other end with Type-C/ Lightning/ Micro USB port to your mobile device.

For example, you can prepare an HDMI adapter with an HDMI port for connecting to the projector, a USB port for charging and a Type-C/ Lightning/ Micro USB port for connecting to your mobile device as below:

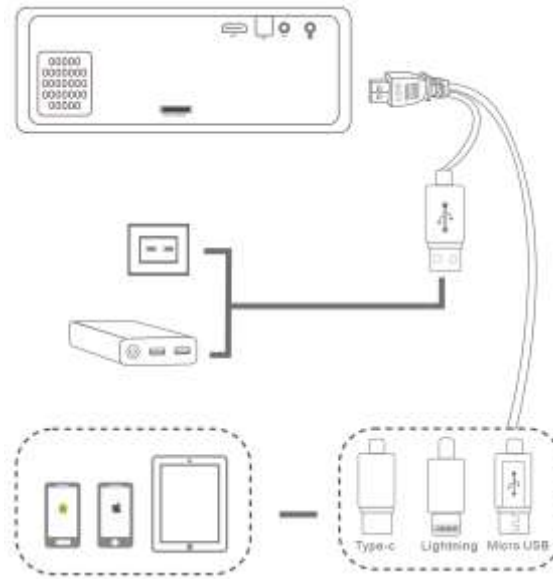

Step 5: Press the  button on the projector or the **Source** button on the remote to enter the interface of **Input Source**;

Step 6: Select **HDMI** to project any file on your mobile device by pressing the **Up/Down** or the **Source** button on the projector or the remote, then press the **OK/Enter** button.

Tip:

1. Select **Trust** when there may be a pop-up window on your mobile device, then you can project any files on the mobile device;



2. When it shows the screen with some QR codes, butterfly icon and so on after selecting, please do not scan any QR code and just wait for a moment;
3. Never directly insert your Lightning cable, Micro USB cable or the Type-c cable to the USB port on the projector. Instead, use an adapter mentioned above to transmit the signal.

Here are some pictures of the proper cable below as reference:



For iPhone



For Android device with Micro USB



For Android device with Type-C

Connecting to the DVD Player

If you would like to watch movies by using the projector and a DVD player, you can use the AV cable in the package.

Step 1: Turn on your DVD player and the projector;

Step 2: Connect the colorful Female connectors to your DVD player' s RCA cable;

Step 3: Connect the yellow Male connector to the **AV In** port on the projector;

Step 4: Press the  button on the projector or the **Source** button on the remote to enter the interface of **Input Source**;

Step 5: Select the correct input source **AV** to project the DVD in your DVD player by pressing the **Up/Down** or the **Source** button on the projector or the remote, then press the **OK/Enter** button.



Using the Basic Projector Features

You can use the projector's **Menu** system to adjust the settings to control how your projector works by pressing the **Menu** button.

TV Settings

1. Insert the coaxial cable in to the **TV** port on the projector;
2. Press the **Left/Right** buttons and the **OK/Enter** button to enter the **TV** settings;



Auto Tuning: the projector will search the TV channels automatically.

ATV Manual Tuning: you can also manually adjust the channels by the **Upward/Downward** buttons.

3. Press the **Up** and **Down** button to select the option you would like to change, then press the **OK/Enter** button to enter the submenu to set up.
4. When you finish changing settings on a menu, press the **Menu** button on the projector or the **Exit** button on the remote to exit.

Picture Settings

1. Press the **Right** button and the **OK/Enter** button to enter the **PICTURE** settings;

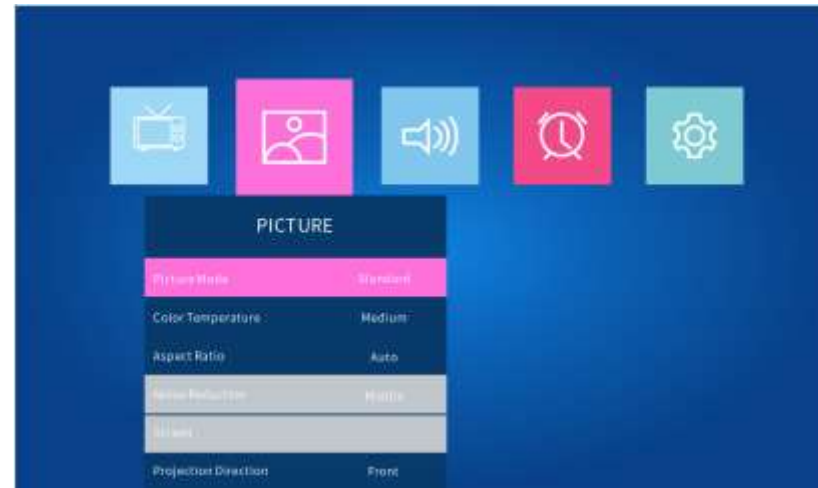

Picture Mode: switches among the image modes of **Standard, Soft, User** and **Vivid** for different projected contents. You can set up the **Contrast, Brightness, Color, Sharpness** and **Tint** for the image after you select the **User** mode;

Color Temperature: switches among the color temperature modes of **Medium, Warm, User** and **Cool** for different color preferences of the image. You can set up color proportions of **Red, Green** and **Blue** for the image after you select **User** mode;

Aspect Ratio: sets up the aspect ratio of the image. It has **4:3, 16:9** and **Auto**;

Noise Reduction: sets up the intensity of noise reduction when the projected contents have sound. It includes **Off, Low, Middle, High** and **Default**;

Screen: when you connect the projector with the computer by VGA, this function will be activated. After selecting **VGA** as input source and choose **Duplicate** display mode, it will show the following interface on the desktop, you can adjust the desktop accordingly. After setting up, you can press the **Menu/Exit** button to back to this **Screen** option under **PICTURE**.



Projection Direction: you can set the projection modes **Front**, **Rear On Desk**, **Front On Ceiling** and **Rear On Ceiling**.

2. Press the **Up** and **Down** button to select the option you would like to change, then press the **OK/Enter** button to enter the submenu to set up.
3. When you finish changing settings on a menu, press the **Menu** button on the projector or the **Exit** button on the remote to exit.

Sound Settings

1. Press the **Right** button and the **OK/Enter** button to enter the **SOUND** Settings:



Sound Mode: to set up sound patterns of **Standard, MUSIC, MOVIE, Sports** and **User** for different projected contents;

Balance: to balance the sound of the left and right channel of the speaker;

Auto Volume: to intelligently adjust volume;

Surround Sound: you can choose different sound mode from **Off, SRS TruSurround XT** and **Surround** options.

2. Press the **Up** and **Down** button to select the option you would like to change, then press the **OK/Enter** button to enter the submenu to set up.
3. When you finish changing settings on a menu, press the **Menu** button on the projector or the **Exit** button on the remote to exit.

Sleep Timer Settings

1. Press the **Right** button and the **OK/Enter** button to enter the **TIME** Settings:

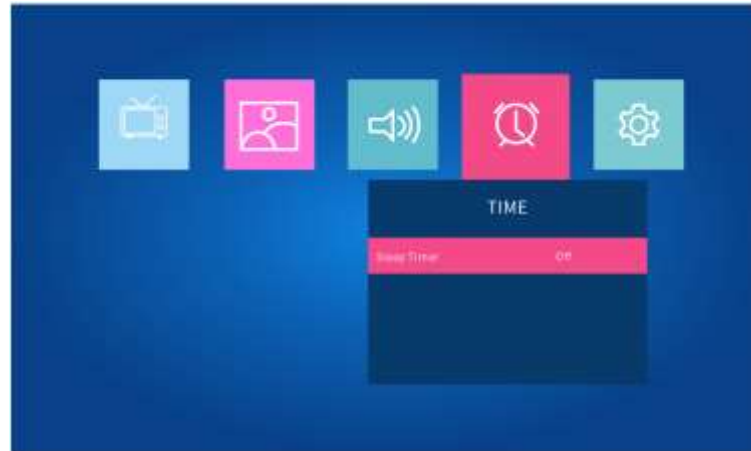

Sleep Timer: can shut off the projector after a set amount of time.

2. Press the **Up** and **Down** button to select the option you would like to change, then press the **OK/Enter** button to enter the submenu to set up.
3. When you finish changing settings on a menu, press the **Menu** button on the projector or the **Exit** button on the remote to exit.

Option Settings

1. Press the **Right** button and the **OK/Enter** to enter the **Option** Settings:

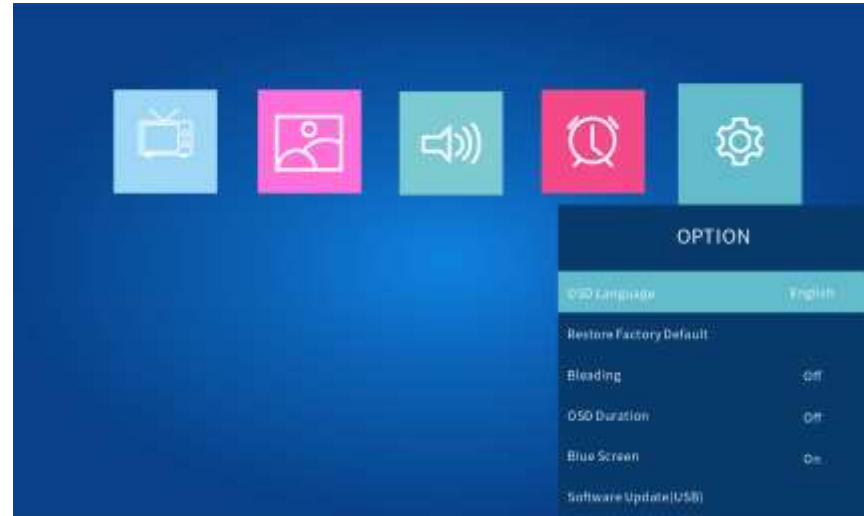

OSD Language: to set up the language displayed in the operation interface.

Restore Factory Default: to reset the projector;

Blending: to adjust the background transparency of **Menu** interface. You can choose from Low, Middle, High and Off;

OSD Duration: to adjust the duration of keeping the **Menu** interface. You can choose from 5 Sec, 10 Sec, 15 Sec and Off;

Software Update (USB): to update the projector's software version.

2. Press the **Up** and **Down** button to select the option you would like to change, then press the **OK/Enter** button to enter the submenu to set up.
3. When you finish changing settings on a menu, press the **Menu** button on the projector or the **Exit** button on the remote to exit.

After Using Your Projector

Please turn off the projector after using it.

1. Press the **Power** button on the projector or the remote;

The projector displays a shutdown confirmation screen below:

Press Power again to power off, or press other button to cancel.

2. Turn off the projector by another press. (To leave it on, press any other button.)
3. Unplug the power cord of the projector;
4. Cover the lens and store the projector in a cool and dry place;

Troubleshooting

Problems listed below might occur during the operation of your projector. Please refer to the possible factors which might cause the issue to do troubleshooting.

1. Why Is the Display of the Projector Available but Without Audio?

*The Projector or the connected device (PC, TV, etc.) is muted

*Dolby sound is not supported, exit to play again

*The audio format is not supported by the projector

*VGA connection can only transmit analog signal of video not audio. An external speaker is required when the device is connected via VGA cable.

*Encryption applied to the videos or media player which holds the video. Try more videos to define this possibility.

*Exclude the above possibilities, try another HDMI cable /external speaker, and a 2.0USB disk/ Micro SD card within 32G/USB hard disk within 1TB to play directly to check if the video and audio are both available.

2. Why Is the Audio of the Projector Available but Without Display?

*The video format is not supported by the projector

*Encryption applied to the videos or media player which holds the video

*If the lamp of the projector is off with only audio playing, the lamp is defective. Please contact Vankyo for a replacement

*Try another HDMI cable if you select the HD input source

3. Why Does the Projection Screen Show **No Signal**?

*Make sure all cables are plugged correctly and firmly

*Make sure you select the right input source. For example, if you insert a USB drive, please select **USB** in the interface of **Input Source**

*USB 2.0 disk is supported on this projector. If a USB 3.0 is connected, it will only show **No Signal**.

4. How Can I do if the Image is Blurry or Out of Shape?

*Adjust the focus and keystone ring by moving it leftward/rightward till it shows the best images

*Place projector on a flat surface horizontally or vertically. An inclination of any angle may result in blurry displays or uneven colors

*Darker environment suggested achieving the best projecting performance

*The eligible distance of 1.16m-5m/32inch-170inch between the projector and projecting screen/wall

*Projecting wall or screen is clean white if possible.

5. How Can I Do if the Image is Up Side Down?

*Enter **Menu-Picture-Projection Direction** to flip the projection image accordingly.

6. How Can I Do if the Projection Screen is Not Square or Allied Horizontally

*Make sure the projector is placed on a flat surface with projector light in the middle of the screen.

*Make sure the projector screen is placed horizontally.

7. How Can I Do if there is Color Distortion?

*Make sure the video source has a fine resolution.

*Adjust the colors: enter **Menu-Picture-Color Temperature**, then select different modes and adjust the value accordingly.

*Reset the projector to manufacturer setting: enter **Menu-Option-Restore Factory Default** to reset.

8. How Can I Do if the Remote is Unresponsive?

*Make sure the batteries are installed correctly and the power is enough.

*The remote works with the projector through the IR receiver. The remote works only when the IR receiver is within the direct reaction distance and will be unresponsive if the IR receiver is blocked or covered.

9. How Should I do if There are Small Dots on Display?

*Tap the projector slightly to shake off the dust which may be caused during installing or shipping

*Clean the lens with clean non-woven fabrics

10. How Should I Do if There is Expanding Dark Spot or Smoke when Using the Projector?

*Check if the fan noise increases or the fan stops working. Unplug the projector and contact Vankyo Team for assistance.

*Make sure the outlet and projector power adapter are not wet or humid which will cause sparks or smoke on outlet when power on the projector.

11. Why Does the Projector is Shut Off During Playing?

*Make sure the power plug is working and firmly fitted into the outlet.

*If the LED indicator on the projector is light up, but the fan doesn't work, please contact Vankyo Team for assistance.

*Overheat on the projector will activate built-in power-off protection panel. Restart the projector when it gets cooler.

*Overload of power when USB disk of 1TB or above is connected without external power supply will cause shutting off. Insert the disk when the projector is powered off or provide an external power supply for disk would solve the issue.

12. Can this Projector Support 3D Effect?

* The projector supports 3D video source, and 3D viewing performance is achievable with Red-Blue 3D Glasses; but please understand the experience will not be better than in the theater and we do not recommend it if you have a higher expectation about 3D effect.

13. Why doesn't Anything Work in the Main Interface Especially with External Storage Connected?

*Correct input source must be selected when you use the USB disk or microSD card; otherwise, **No Signal** will be shown on the screen.

14. Why doesn't the Projector's Lamp Light Up or Power On?

*Please contact Vankyo for assistance when this occurs.

15. How Can I Change the Language?

*Press the **Menu** button to enter **Option -OSD Language** interface to select the language

16. How Can I Connect My Smart Phone to the Projector?

*HDMI adapter is needed to deliver display from smart phones. Adapters vary depending on smart phones.

17. What kind of Screws do I need for mounting this Projector?

* British Standard Pipe Thread of 1/4 inch

18. What Kind of Cable do I Need when Connecting TV BOX, TV, Firestick and DVD Player to the Projector?

*HDMI cable for all devices mentioned above. For some TV without HDMI port, VGA cable will work. Certain DVD players require the AV cable connection.

19. How Can I Display PowerPoint on the Projector?

*To project the PowerPoint from a computer or other mobile devices, you can just connect the computer or the mobile device to the projector following the steps mentioned [here](#);

*To project from a USB disk, PowerPoint is not supported. However, we can save PowerPoint profile as PNG, or JPG or other image formats which are supported by the projector, then select the photos that we plan to do loop play. Default interval of each photo is about 5 second and we can pause it by controlling through the button on the remote or the projector.