



Owner's Manual

LG Minibeam UST

DLP Projector

Please read the safety information carefully before using this product.

PF1000UW

www.lg.com

P/NO : SAC37034661 (1702-REV00)

LICENSES

Supported licenses may differ by model. For more information about licenses, visit www.lg.com.

 **DOLBY AUDIO**™ Manufactured under license from Dolby Laboratories. Dolby, Dolby Vision, Dolby Audio, and the double-D symbol are trademarks of Dolby Laboratories.

 **HDMI**™
HIGH-DEFINITION MULTIMEDIA INTERFACE The terms HDMI and HDMI High-Definition Multimedia Interface, and the HDMI logo are trademarks or registered trademarks of HDMI Licensing LLC in the United States and other countries.

 **dts-HD**® For DTS patents, see <http://patents.dts.com>. Manufactured under license from DTS Licensing Limited. DTS, DTS-HD, the Symbol, & DTS or DTS-HD and the Symbol together are registered trademarks of DTS, Inc. © DTS, Inc. All Rights Reserved.

This device meets the EMC requirements for home appliances (Class B) and is intended for home usage. This device can be used in all regions.



NOTE

- Image shown may differ from your projector.
- Your projector's OSD (On Screen Display) may differ slightly from that shown in this manual.

SAFETY PRECAUTIONS

Please take note of the safety instructions to prevent any potential accident or misuse of the projector.

- Safety precautions are given in two forms, i.e., **WARNING** and **CAUTION** as detailed below.

 **WARNING** Failure to follow the instructions may cause serious injury and even death.

 **CAUTION** Failure to follow the instructions may cause personal injury or product damage.

- Read the owner's manual carefully and keep it on hand.





WARNING/CAUTION

RISK OF ELECTRIC SHOCK

DO NOT OPEN



 The lightning flash with arrowhead symbol, within an equilateral triangle, is intended to alert the user to the presence of uninsulated dangerous voltage within the product's enclosure that may be of sufficient magnitude to constitute a risk of electric shock to persons.

 The exclamation point within an equilateral triangle is intended to alert the user to the presence of important operating and maintenance (servicing) instructions in the literature accompanying the appliance.

WARNING/CAUTION

- TO REDUCE THE RISK OF FIRE AND ELECTRIC SHOCK, DO NOT EXPOSE THIS PRODUCT TO RAIN OR MOISTURE.

Read these instructions.

Keep these instructions.

Heed all warnings.

Follow all instructions.

Indoor Installation

WARNING

- Do not use the projector outside and do not expose the product to any humidity or water.
 - Since the product is not waterproof, this may result in a fire or electric shock.
- Do not place the projector in direct sunlight or near heat sources such as radiators, fires, stoves, etc.
 - This may result in fire.
- Do not place flammable materials such as aerosols near the projector.
 - This may result in fire.
- Do not allow children to cling to or climb up to the projector.
 - This may cause the projector to fall, causing injury or death.

- Do not install the product in a place with no ventilation (e.g., on a bookshelf or in a closet) or on a carpet or cushion.
 - This may result in fire due to the increase in internal temperature.
- Do not place the product close to sources of steam, oil or oil mist, such as humidifiers and kitchen counters.
 - Failure to do so may result in fire, electric shock, or corrosion.
- Do not install the product onto a wall or ceiling that is close to sources of oil or oil mist.
 - The product may be damaged and fall, resulting in serious injury.
- Do not place the projector where it might be exposed to dust.
 - This may result in fire.
- Do not use the projector in a damp place such as a bathroom where it is likely to get wet.
 - This may result in fire or electric shock.
- Do not allow a tablecloth or curtain to block the air vent.
 - This may result in fire due to the increase in the internal temperature.
- Ensure good ventilation around the projector. The distance between the projector and the wall should be at least 30 cm.
 - This will prevent fire due to the increase in the internal temperature.

 **CAUTION**

- When placing the projector on a table or shelf, be careful not to put it near the edge.
 - The projector could fall due to balance problems, which may cause personal injury or damage to the product. Make sure to use the projector cabinet or stand that fits the projector.
- When moving the projector, make sure to switch it off and remove the power plug and cords.
 - The power cord may be damaged, resulting in fire or electric shock.
- Do not place the projector on an unstable or vibrating surface such as a wobbly shelf or a slope.
 - It may fall and cause injury.
- Be careful not to tip the projector over when connecting external devices to the projector.
 - This may cause personal injury or damage to the projector.

Power

WARNING

- DISCONNECTING THE DEVICE FROM THE MAIN POWER
 - The Power plug is the disconnecting device. In case of an emergency, the Power Plug must remain readily accessible.
- The grounding wire should be connected. (Except for devices which are not grounded.)
 - Ensure that you connect the grounding cable to avoid electric shock. If it is not possible to ground the unit, have a qualified electrician install a separate circuit breaker. Do not try to ground the projector by connecting it to telephone wires, lightning rods or gas pipes.
- The power plug should be inserted fully into the power outlet.
 - An unstable connection may cause a fire.
- Do not place heavy objects on the power cord.
 - This may result in fire or electric shock.
- Never touch the power plug with wet hands.
 - This may result in electric shock.
- Do not plug too many devices into one multi-power outlet.
 - This may result in fire due to the power outlet overheating.
- Keep the AC adapter, power plug, and the used power outlet clean from dust or foreign materials building up.
 - This may result in fire.
- If there is any smoke or a burning smell from the projector or AC adapter, stop using the product immediately. Disconnect the power cord from the power outlet, and then contact the customer service center.
 - This may result in fire.
- To turn off the main power, remove the power plug, which should be positioned so it is easy to access for operation.

 **CAUTION**

- Always grab the plug to remove the AC adapter or power cord.
 - Otherwise, this may result in a fire or may damage the product.
- Refrain from constantly bending the power cord of the AC adapter.
 - If the power cord is bent excessively for a long period of time, the cord may break inside. This may result in a fire or electric shock.
- Ensure the power cord and plug are not damaged, modified, severely bent, twisted, pulled, sandwiched or hot. Do not use the product if the power outlet is loose.
 - This may result in fire or electric shock.
- Keep the power cord away from heating devices.
 - The wire's sheath may melt, which may result in fire or electric shock.
- Place the projector where people will not trip over or step on the power cord to protect the power cord and plug from any damage.
 - This may result in fire or electric shock.
- Do not turn the projector on or off by plugging in the power plug or unplugging it from the power outlet. (Do not use the power plug as a switch.)
 - This may result in electric shock or damage to the product.
- Do not insert a conductor into the other side of the wall outlet while the power plug is inserted into the wall outlet. In addition, do not touch the power plug immediately after it is disconnected from the wall outlet.
 - This may result in electric shock.
- Only use the official power cord provided by LG Electronics. Do not use other power cords.
 - This may result in fire or electric shock.
- If any water or foreign materials have gone into the AC adapter, power cord, or the interior of the projector, turn off the projector by pressing the power button. Remove all the cables, and then contact the customer service center.
 - This may result in fire or electric shock.
- The surface of the AC adapter is hot. Keep the AC adapter out of the reach of children and avoid touching it during use.

- Never disassemble the power supply devices (AC adapter/power cord, etc.).
 - This may damage the power cord and result in a fire or electric shock.
- Connect the AC adapter and the power cord firmly.
 - Not doing so may result in a product failure or fire.
- Do not place heavy objects or put pressure on the power cord and AC adapter and avoid damage.
 - This may result in a fire or may damage the product.
- Always use the AC adapter provided or any AC adapters approved and certified by LG Electronics.
 - Any other AC adapter connected may result in the screen flickering.

When in Use

WARNING

- Do not place anything containing liquid on top of the projector such as a vase, flower pot, cup, cosmetics, medicine, or ornaments, candles, etc.
 - This may result in fire or electric shock, or cause injury due to falling.
- In the event that there is a heavy impact or the cabinet is damaged, switch it off, unplug it from the power outlet and contact an authorized service center.
 - This may result in electric shock.
- Do not insert pieces of metal such as coins, hairpins or metal debris, nor flammable materials such as paper or matches into the projector.
 - This is to prevent electric shock or fire.
- Make sure that a child does not swallow the batteries when you replace the old batteries in the remote control with new ones. Keep batteries out of reach of children.
 - If a child swallows a battery, consult a doctor immediately.
- Never open any cover on the projector.
 - There is a high risk of electric shock.

- Do not look directly into the lens when the projector is in use.
 - The bright light may damage your eyes.
- When the lamp is on or has just been turned off, avoid touching the air vent or lamp, because these will be very hot.
- If there is a gas leak in the room with the projector, do not touch the projector or power outlet. Open the windows for ventilation.
 - Sparks may cause fire or burns.
- Unplug the power cord from the outlet during a lightning storm.
 - This will prevent shock or damage to the projector.
- Do not use the projector near electronic devices that generate a strong magnetic field.
- Keep the plastic film used for packaging the projector out of the reach of children.
 - If not handled safely, it can cause suffocation.
- Do not keep your hand on the projector for a long time when it is running.
- When you play a game by connecting a game console to a projector, it is recommended that you maintain a distance of more than four times the diagonal length of the screen.
 - Make sure that the connecting cable is long enough. Otherwise, the product may fall causing personal injury or damage to the product.
- Do not place the projector or its remote control with batteries in an extremely high temperature environment.
 - This may result in fire.

 **CAUTION**

- Do not place heavy objects on the projector.
 - It may fall down and cause personal injury.
- Be careful not to allow any impact to the lens during transport.
- Do not touch the lens of the projector.
 - The lens may be damaged.
- Do not use any sharp tools on the projector such as a knife or hammer, because this may damage the casing.
- In the event that no image appears on the screen or no sound is heard, stop using the projector. Switch off the projector, unplug it from the power outlet and contact our service center.
 - This may result in fire or electric shock.
- Do not drop anything onto the projector or allow anything to bang into the projector.
 - This may cause damage to the projector or personal injury.
- It is recommended that you maintain a distance of more than 5 to 7 times the diagonal length of the screen.
 - If you watch the screen at a close distance for a long time, your eye sight may become worse.
- Do not block the light beam emitted from the projector using a book or other object.
 - Lengthy exposure to the projector beam may result in fire. In addition, the lens may be overheated and damaged by the reflected heat. Disable the AV function to stop projection temporarily or turn off the power.
- Do not start the projector with the volume turned up high.
 - High volume may damage hearing.
- Do not use high voltage electrical equipment near the projector, (e.g., a bug zapper). This may result in product malfunction.

Cleaning

WARNING

- Do not spray the projector with water when cleaning. Make sure water does not flow into the projector.
 - This may result in fire or electric shock.
- When there is smoke or a strange smell coming out from the projector or a foreign object falls into the projector, please switch it off and unplug it from the power outlet and contact our service center.
 - Otherwise, this may result in fire or electric shock.
- Use air spray, a soft cloth or a cotton swab moistened with a lens cleaning chemical or alcohol to remove dust or stains on the front projection lens.

CAUTION

- Contact your seller or our service center once a year to clean the internal parts of the projector.
 - If you do not clean the projector for a long period of time, dust will accumulate, which may result in fire or damage to the projector.
- When cleaning plastic parts such as the projector case, unplug the power first and wipe with a soft cloth. Do not spray with water or wipe with a wet cloth. Never use glass cleaner, automobile or industrial polish, abrasives, wax, benzene, or alcohol as these can damage the projector.
 - This can result in fire, electric shock or cause damage to the product (deformation and corrosion).

- Do not wipe the optical system (lens, mirror) right after the product has been turned off or while the product is being operated. When cleaning each part of the product, remove the power cord and wipe gently with a soft cloth. Do not spray with water or wipe with a wet cloth. Do not use detergents, automobile or industrial polish, abrasive substances, wax, benzene, alcohol, water, etc. on the product's main unit or optical system (lens, mirror) as this may damage the product.
 - This can result in fire, electric shock or cause damage to the product (deformation and corrosion).
- Remove the plug from the outlet before cleaning the product.
 - Otherwise, this may result in electric shock.

Others

WARNING

- When you go out, place the projector out of reach of animals, and remove the power plug from the wall outlet.
 - Using a damaged power cord may result in short circuit or fire.
- Do not use the projector near high-precision electronic devices or those that transmit weak radio signal.
 - This may affect the operation of the product, causing an accident.
- Only a qualified technician can disassemble or modify the projector. For diagnosis, adjustment, or repair, contact your seller or our service center.
 - This may result in fire or electric shock.
- Proper ventilation required, do not block airflow around unit. Doing so can cause injury and internal overheating.
- To prevent damage to lamp, unit must remain plugged in for approximately 3 minutes after power down to allow for proper cool down (not applicable on LED models).

- Do not touch the lens; doing so can result in burns or damage to lens. Lens and unit may be HOT during and immediately after use. Use caution when handling unit, allowing for proper cool down.
- Only use a grounded electrical outlet. (Except for devices which are not grounded.)
- Do not insert anything into or cover up the exhaust vents.
 - This may result in fire or electric shock.
- Follow all maintenance guidelines for optimal use; service only at an authorized service center.
- Lamp contains mercury and as such must be disposed of according to local, state and federal laws (not applicable on LED models).
- Keep the batteries and remote out of reach of children.
 - This will prevent personal injury or damage to the product.

 **CAUTION**

- Do not use or store the projector outdoors for long periods of time.
- Do not mix new batteries with old ones.
 - Burst or leaking batteries may result in damage or injury.
- Be sure to unplug if the projector is not to be used for a long period.
 - Accumulated dust may result in fire or electric shock due to overheating, ignition, or poor insulation.
- Only use the specified type of battery.
 - Burst or leaking batteries may result in damage or injury.
- Make sure you use the same type of battery when replacing.
 - In the case of a battery contact failure, the battery may drain quickly or the remote control may not work properly.
- Dispose of used batteries properly.
 - This may result in explosion or fire. The correct method of disposal may vary depending on your country or region. Dispose of the battery pack as instructed.
- Do not throw or disassemble the battery.
 - This may result in fire or explosion due to damage to the battery.

- Store batteries away from metallic objects, such as keys and paper clips.
 - Excess current may cause a rapid increase in temperature, resulting in fire or burns.
- Do not store the batteries near any heat source, such as a heater.
 - This may result in fire or damage to the product.
- Do not store batteries at temperatures higher than 60 °C or in high humidity.
 - This may result in explosion or fire.
- Make sure that the battery is installed correctly.
 - This prevent explosion or fire.
- Incorrect battery replacement may cause fire.
- Batteries: Store the accessories (battery, etc.) in a safe location out of the reach of children.

Risk Group 2

CAUTION Possibly hazardous optical radiation emitted from this product. Do not stare at operating lamp. May be harmful to the eye.

This label is attached to the bottom of the product and language may differ.

ANTENNA

WARNING

- If you are using an outdoor antenna, please install it away from electrical wires to make sure it does not touch any nearby wires even when it falls down due to heavy wind.
 - Failure to do so may cause electric shock or physical injury.

CAUTION

- To prevent any water flowing into the product, install a drip loop in the outdoor antenna wire where it comes indoors.
 - Raindrops flowing into the product may cause fire or electric shock.

Outdoor Antenna Grounding

- If an outdoor antenna is installed, follow the precautions below. An outdoor antenna system should not be located in the vicinity of overhead power lines or other electric light or power circuits, or where it can come in contact with such power lines or circuits as death or serious injury can occur. Be sure the antenna system is grounded to provide some protection against voltage surges and built-up static charges. Section 810 of the National Electrical Code (NEC) in the U.S.A. provides information with respect to proper grounding of the mast and supporting structure, grounding of the lead-in wire to an antenna discharge unit, size of grounding conductors, location of antenna discharge unit, connection to grounding electrodes and requirements for the grounding electrode.

Antenna grounding according to the National Electrical Code, ANSI/NFPA 70

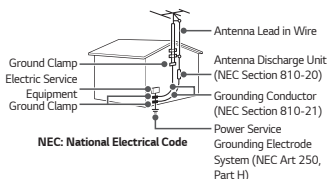

For USA

NOTE TO CABLE/TV INSTALLER

This reminder is provided to call the CATV system installer's attention to Article 820 - 40 of the National Electric Code (U.S.A.). The code provides guidelines for proper grounding and, in particular, specifies that the cable ground shall be connected to the grounding system of the building, as close to the point of the cable entry as practical.

CONTENTS

LICENSES	2	USING THE PROJECTOR	30
SAFETY PRECAUTIONS	3	Connecting the Antenna or Cable	30
PREPARATION	16	– Focus of the Screen Image	31
Accessories	16	– Watching With the Projector	31
Optional Extras	17	CONNECTING DEVICES	32
Parts and Components	18	Connecting to HD Receiver, DVD, or External Devices	33
– Main Unit	18	– HDMI Connection	33
– Side	19	Connecting a PC	34
– Back	20	– HDMI Connection	34
Using the Joystick Button	21	Connecting a Laptop	34
– Basic functions	21	– HDMI Connection	34
– Adjusting the menu	22	Connecting Headphones	35
Projector Status Indicators	22	Connecting a Digital Amp	36
Installation	23	MAINTENANCE	37
– Installation Precautions	23	Cleaning	37
– Projection Distance per Screen Size	24	– Cleaning the Lens	37
– Kensington Security System	25	– Cleaning the Projector Case	37
MAGIC REMOTE CONTROL	26	SPECIFICATIONS	38
To Register the Magic Remote Control	28		
To Re-register the Magic Remote Control	28		
Using the Magic Remote Control	29		

PREPARATION

The pictures may differ slightly from the actual product.

Accessories

Accessories included with the projector are show below.

Accessories are subject to change without prior notice.

New accessories may be added or old ones removed.

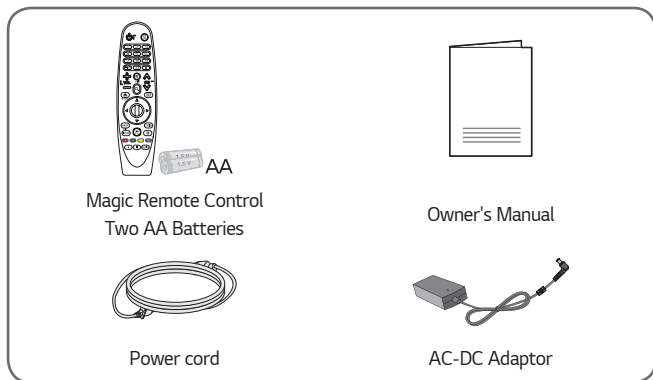

- When connecting an HDMI or USB cable, or connecting a USB flash drive to the HDMI or USB port, use a product that has a width of 18 mm or less and a height of 10 mm or less. If the USB cable or USB flash drive does not fit the USB ports of the projector, use an extension cable that supports USB 2.0.

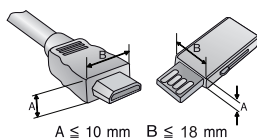

- When connecting two USB devices at the same time, each one should have bezels less than 8.5 mm thick.
- Use a certified cable with the HDMI logo attached.
- If you do not use a certified HDMI cable, the screen may not display or a connection error may occur. (Recommended HDMI cable types)
 - High-Speed HDMI[®]/™ Cable
 - High-Speed HDMI[®]/™ Cable with Ethernet

Optional Extras

To purchase optional accessories, visit an electronics store or online shopping site or contact the retail store where you purchased the product. Optional accessories are subject to change without prior notice.



Projection Screen



HDMI Cable



RF Cable



Optical Cable

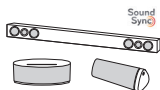

LG Audio Device



Audio Cable

Parts and Components

This projector is manufactured using high-precision technology. You may, however, see tiny black dots and/or bright colored dots (red, blue, or green) that continuously appear on the projector screen. This is a normal result of the manufacturing process and does not indicate a malfunction.

Main Unit

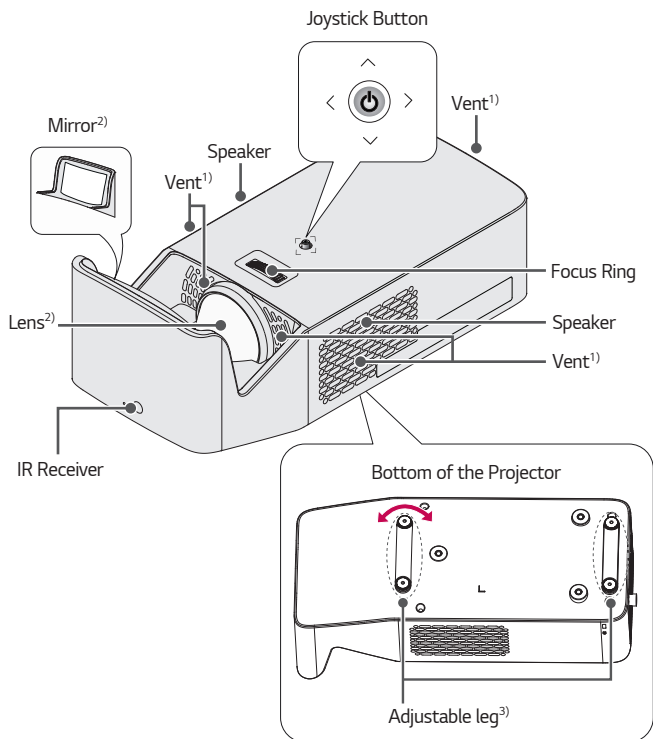

- 1) Due to the high temperature of vent area, do not get close to the vent area.
- 2) Do not touch the lens and mirror when using the projector. The lens may be damaged. (Keep lens away from sharp objects.)
- 3) Turn the adjustable leg left or right to adjust the angle.

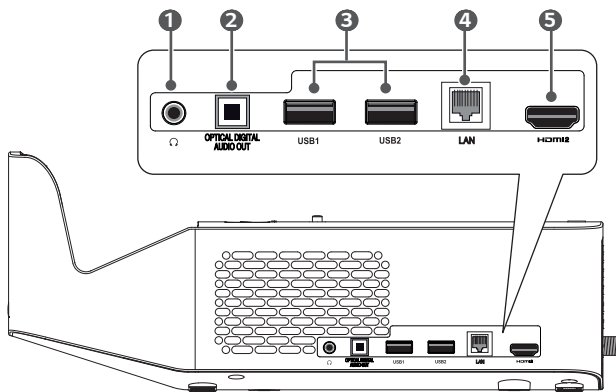
Side

No.	Description
①	🎧 (Headphone Port)
②	OPTICAL DIGITAL AUDIO OUT Port
③	USB 1 / USB 2 Port
④	LAN Port
⑤	HDMI 2 Port

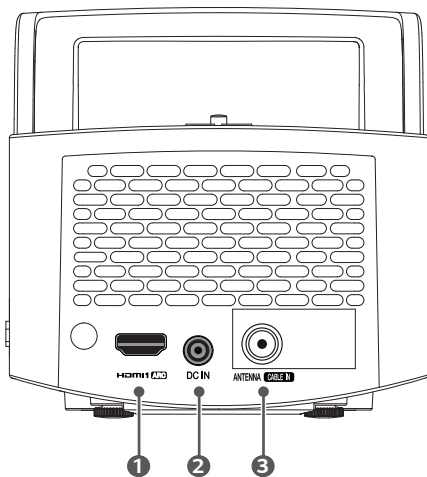

Back

No.	Description
①	HDMI 1 ARC Port
②	DC IN Port
③	ANTENNA CABLE IN Port

Using the Joystick Button

You can operate the projector by pressing the button or moving the joystick left, right, up, or down.

Basic functions

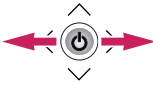
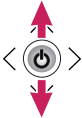
	Power On	When the projector is turned off, place your finger on the joystick button, press it once, and release it.
	Power Off	When the projector is turned on, place your finger on the joystick button, press it once for a few seconds, and release it. (However, if the Menu button is on the screen, pressing and holding the joystick button will let you exit the Menu.)
	Volume Control	Place your finger over the joystick button and move it left or right, you can adjust the volume level.
	Channels Control	Place your finger over the joystick button and move it up or down, you can scroll through the saved channels.







NOTE

- Place your finger over the joystick button and move it up, down, left, or right. Be careful not to press the joystick button. If you press the joystick button first, you may not be able to adjust the volume level and/or scroll through saved channels.

Adjusting the menu

When the projector is turned on, press the joystick button one time.

You can adjust the menu items (⏻, 📺, ✕, ⚙️) moving the joystick button left, right, up, or down. Move to the desired menu item, and then press the joystick button once to select it.

	Turns the power off.
	Changes the input source.
	Clears on-screen displays and returns to projector viewing.
	Displays the Settings menu.

Projector Status Indicators

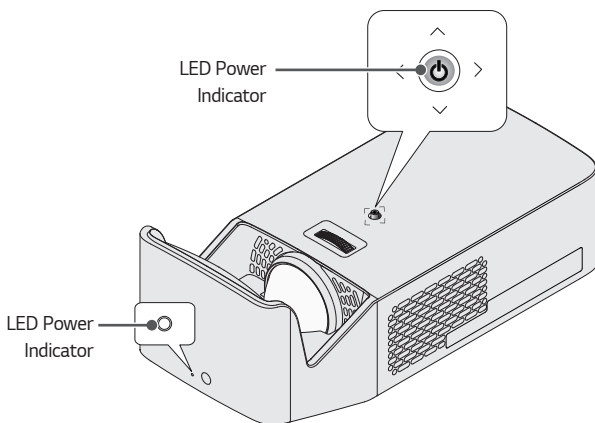

LED Power Indicator	
Red	Power standby state
Off	The projector is operating with the power on.

Installation

Installation Precautions

- Place the projector in a well-ventilated environment.
 - To prevent internal overheating, install the projector in a well-ventilated place. Do not place anything near the projector. That may block its air vents. If the air vents are blocked, the internal temperature of the projector will increase.

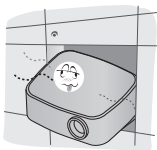

- Do not place the projector on a carpet or rug. If the projector's inlet vent is on the bottom, be careful not to block the vent and always use the projector on a solid, level surface.



- Be sure to prevent foreign objects such as paper debris from entering the projector.



- Leave an adequate open area (30 cm or more) around the projector.

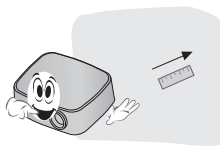

- Do not place the projector in a hot, cool, or humid environment.
- Do not place the projector in a place where it will easily attract dust.
 - This may result in fire.
- Never open any cover on the projector. There is a high risk of electric shock.
- The projector is manufactured using high-precision technology. You may, however, see tiny black dots and/or bright colored dots (red, blue or green) that continuously appear on the projector screen. This is a normal result of the manufacturing process and does not indicate a malfunction.
- The remote control may not work in an environment where a lamp equipped with electronic ballasts or a three-wavelength fluorescent lamp is installed. Replace the lamp with an international standard lamp for the remote control to work normally.
- To install to the ceiling, attach the ceiling-type bracket to the projector with M4 x 8 mm screws.

Projection Distance per Screen Size

- 1 Place the projector on a sturdy, level surface, together with the PC or audio/video source.
- 2 Place the projector an appropriate distance away from the screen. The distance between the projector and the screen determines the actual size of the image.
- 3 Position the projector so that the lens is at a right angle to the screen. If the projector is not at a right angle, the projected image will look distorted. To correct the distortion, use the Edge Adjustment function.
- 4 Connect the power cord of the projector and the connected device to the wall outlet.

Ratio of upward projection: 125 %

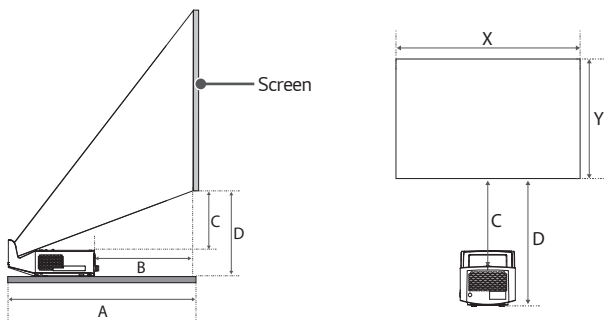

Screen Size [mm]	1524	1778	2032	2286	2540
Horizontal Size (X) x Vertical Size (Y) [mm]	1328 x 747	1550 x 872	1771 x 996	1992 x 1121	2214 x 1245
A [mm]	414	482	550	618	686
B [mm]	105	173	241	309	377
C [mm]	149	181	213	245	276
D [mm]	241	273	304	336	368

The projection distance may vary depending on the installation conditions.



NOTE

- If the projected image looks distorted or bent, check to see if the screen is installed properly.

Kensington Security System

- This projector has a Kensington Security Standard connector as an anti-theft mechanism. Connect a Kensington Security System cable as shown below.
- For more information on installation and use of the Kensington Security System, refer to the user's guide provided with the Kensington Security System.
- The Kensington Security System is an optional accessory.
- What is Kensington?
Kensington is a company that provides safety systems for laptops and other electronic devices. Website: <http://www.kensington.com>

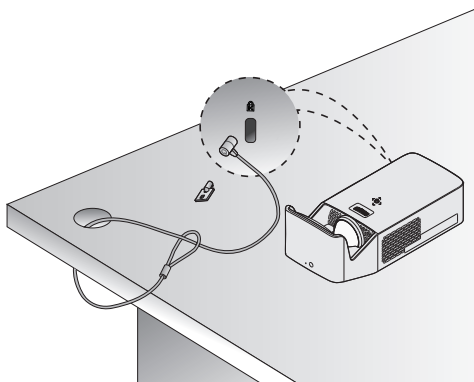

MAGIC REMOTE CONTROL

If the battery low message appears while using the Projector, replace the batteries.

As shown in the figure, press the top of the battery cover and slide it down the cover. Insert two new and identical batteries (1.5 V, AA type) with + and - poles pointing in the correct direction in the remote control.

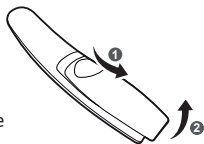

NOTE

- Do not mix new batteries with old ones.

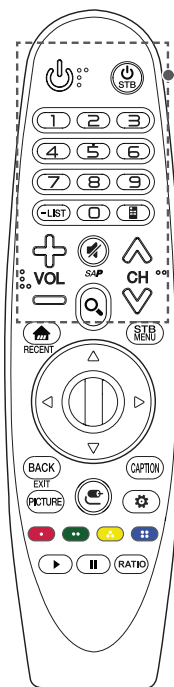

(POWER)

Turns the Projector on or off.

STB (STB POWER)

You can turn your set-top box on or off by adding the set-top box to the universal remote control for your Projector.

Number buttons

Enters numbers.

- (Dash)

Inserts a dash between numbers such as 2-1 and 2-2.

LIST

Accesses the saved channel list.

(Screen Remote)

Displays the Screen Remote.

- Accesses the Universal Control Menu in some regions.

VOL

Adjusts the volume level.

(MUTE)

Mutes all sounds.

SAP *

Video descriptions function will be enabled.

- **SAP** (Secondary Audio Program) Feature can also be enabled by pressing the  key.

CH

Scrolls through the saved channels.

(SEARCH)

Search for content such as channels, movies and other videos, or perform a web search by entering your search terms in the search box.

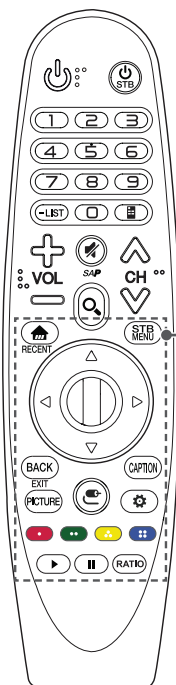

Accesses the Home menu.

RECENT *

Shows the previous history.

STB MENU

Displays the set-top box Home menu.

(When you are not watching with a set-top box the set-top box screen is displayed.)

△ ▽ ◀ ▶ (Up/Down/Left/Right)

Press the up, down, left or right button to scroll the menu.

If you press △ ▽ ◀ ▶ buttons while the pointer is in use, the pointer will disappear from the screen and Magic Remote will operate like a general remote control. To display the pointer on the screen again, shake Magic Remote to the left and right.

Wheel (OK)

Press the center of the Wheel button to select a menu. You can change channels by using the Wheel button.

BACK

Returns to the previous screen.

EXIT *

Clears all on-screen displays and returns to Projector viewing.

PICTURE

Changes the picture mode.

CAPTION

Activates or deactivates the subtitles.

(INPUT)

Changes the input source.

– Pressing and holding the (INPUT) button displays all the lists of external inputs.

⚙️ (Q. Settings)

Accesses the Quick Settings.

– Pressing and holding the ⚙️ (Q. Settings) button displays the All Settings menu.

Coloured buttons

These access special functions in some menus.

(●: Red, ●: Green, ●: Yellow, ●: Blue)

Control buttons (▶, ||)

You have access to premium content, video content and devices that support SIMPLINK.

RATIO

Changes the aspect ratio of the screen per pressing of the button.



*: To use the button, press and hold for more than 3 seconds.

To Register the Magic Remote Control



To use the Magic Remote control, register it with your projector first.

- 1 Put batteries into the Magic Remote and turn the Projector on.
 - 2 Point the Magic Remote at your projector and press the  **Wheel (OK)** on the remote control.
- If the projector fails to register the Magic Remote, try again after turning the projector off and back on.

To Re-register the Magic Remote Control

- 1 Press the  and **BACK** buttons at the same time, for five seconds, to unpair the Magic Remote with your projector.
 - 2 Press the  **Wheel (OK)** button towards the projector to re-register the magic remote control.
- Pressing and holding the **CAPTION** button will let you cancel and re-register Magic Remote at once.

Using the Magic Remote Control

- Shake the Magic Remote slightly to the right and left or press ,  (INPUT) buttons to make the pointer appear on the screen.
- If the pointer has not been used for a certain period of time or Magic Remote is placed on a flat surface, then the pointer will disappear.
- If the pointer is not responding smoothly, you can reset the pointer by moving it to the edge of the screen.
- The Magic Remote depletes batteries faster than a normal remote due to the additional features.

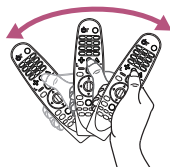
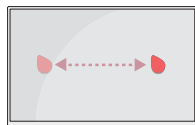

CAUTION

- Use the remote control within the specified range (within 10 m). You may experience communication failures when using the device outside the coverage area or if there are obstacles within the coverage area.
- You may experience communication failures depending on the accessories. Devices such as a microwave oven and wireless LAN operate in the same frequency band (2.4 GHz) as the Magic Remote. This may cause communication failures.
- The Magic Remote may not work properly if a wireless router (AP) is within 1 m of the projector. Your wireless router should be more than 1 m away from the projector.
- Do not disassemble or heat the batteries.
- Do not drop the battery. Avoid extreme shocks to the battery.
- Inserting a battery in the wrong way may result in explosion.

USING THE PROJECTOR

Connecting the Antenna or Cable

To watch TV using an indoor/outdoor antenna, connect a wall terminal and the antenna port of the projector using an RF cable (75 Ω).

You can watch terrestrial or cable (analog, digital) TV. (The RF cable is sold separately.)

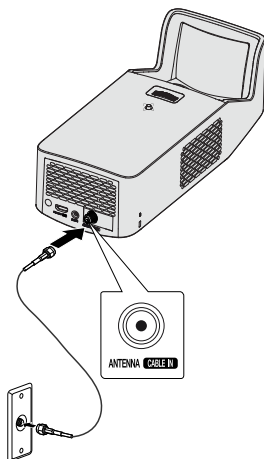

NOTE

- Make sure not to bend the copper wire of the RF cable (75 Ω). Turn the input jack to the right to fasten it.
- Ensure you use a standard coaxial cable (75 Ω , sold separately) when connecting to the projector input.
- For better image quality in locations where signal strength is low, purchase and install a signal amplifier (booster).
- A signal splitter is required if you want to use two or more projectors through one antenna.
- If you have any problems when installing the antenna, please consult a suitable retailer or the store where you purchased the antenna.

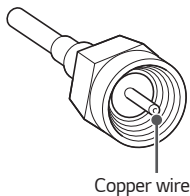



Focus of the Screen Image

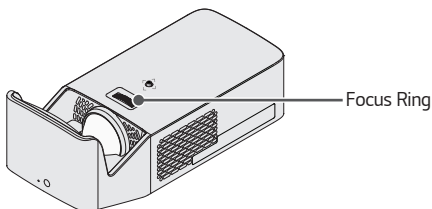

When an image appears on the screen, check if it is in focus and fits the screen properly.



- To adjust the focus of the image, rotate the focus ring.
- Make sure the product does not move when adjusting the focus.

Watching With the Projector

- 1 When in standby mode, press the  (**POWER**) button to turn the projector on.
- 2 Select the  (**INPUT**) → **All Inputs** and select the input signal you want.
- 3 Control the projector using the following buttons while watching projector.

Button	Description
 CH	Changes the TV channel.
 VOL	Adjusts the volume level.
 (MUTE)	Mutes the sound from the projector.

- 4 To turn the projector off, press the  (**POWER**) button.

CONNECTING DEVICES

You can connect various external devices to the projector.

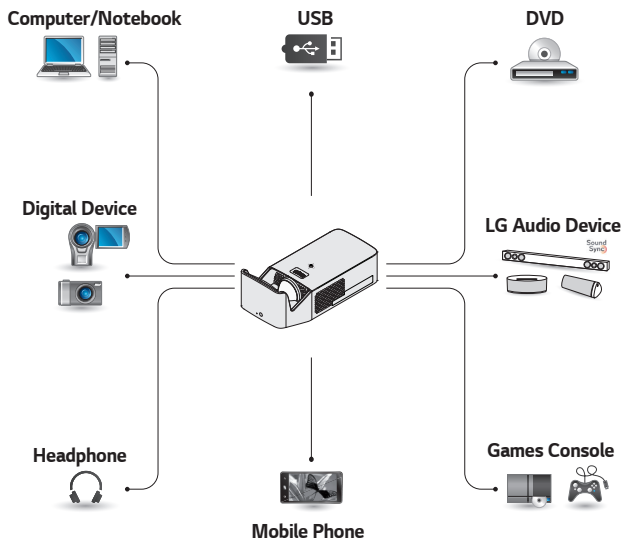

HDMI - Page 33

Headphone - Page 35

Digital Amp - Page 36

Connecting to HD Receiver, DVD, or External Devices

Connect an HD receiver, DVD, or external devices to the projector and select an appropriate input mode.

HDMI Connection

-  (INPUT) → All Inputs → **HDMI1/HDMI2**

With an HDMI cable, you can enjoy high quality picture and sound.

Using a HDMI cable, connect the

HDMI2 port of the projector to the HDMI output port of the device to connect. Both video and audio are output at the same time. You can also use the **HDMI1 ARC**.

You can connect with any HDMI input port.

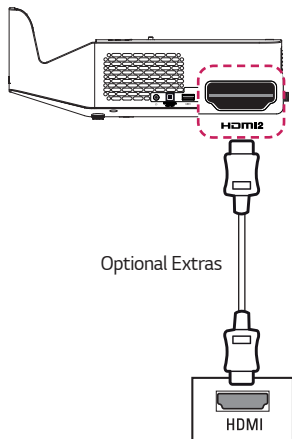

! NOTE

ARC(Audio Return Channel)

- External audio devices that support SIMPLINK and ARC must be connected using **HDMI1 ARC** port.
- When connected with a high-speed HDMI® cable, external audio devices that support ARC output or SPDIF work with the SIMPLINK function without the need for an additional optical audio cable.

Connecting a PC

The projector supports Plug and Play. Your PC will automatically detect the projector and requires no driver installation.

HDMI Connection

-  (INPUT) → All Inputs → **HDMI1/HDMI2**

Using an HDMI cable, connect the **HDMI2** port of the projector to the HDMI output port of your PC. Both video and audio are output at the same time. You can also use the **HDMI1 ARC**.

You can connect with any HDMI input port.

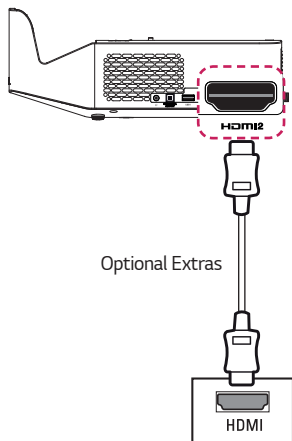

Connecting a Laptop

You can connect the projector to a laptop to use various functions.

HDMI Connection

-  (INPUT) → All Inputs → **HDMI1/HDMI2**

Using an HDMI cable, connect the **HDMI2** port of the projector to the HDMI output port of your laptop. Both video and audio are output at the same time. You can also use the **HDMI1 ARC**.

You can connect with any HDMI input port.

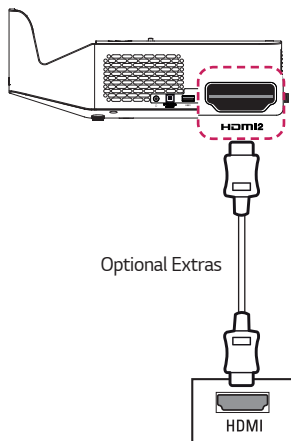

The table below shows examples of switching the output. For more information, refer to the **External Output, Connecting to an External Monitor**, or similar sections of the owner's manual of your computer.

Brand	Switching Output
NEC	[Fn]+[F3]
Panasonic	[Fn]+[F3]
Toshiba	[Fn]+[F5]
IBM	[Fn]+[F7]
Sony	[Fn]+[F7]
Fujitsu	[Fn]+[F10]
LG	[Fn]+[F7]
Samsung	[Fn]+[F4]
Macintosh	Adjust the control panel to enable mirroring after start-up.

Connecting Headphones

You can listen to the audio through a headphone.

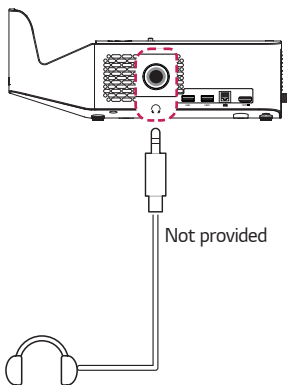

Connecting a Digital Amp

Using an optical cable, connect the digital audio input port of a digital amp to the **OPTICAL DIGITAL AUDIO OUT** port of the projector. The output of an amp with a digital converter must be set to the desired audio format. When using a HDMI cable to connect a home theater or when connecting an optical output to an external audio device, set **Sound Out** to **Audio Out (Optical/HDMI ARC)**. If a projector, home theater, or the speaker of an external audio device is operating at the same time, there will be an echo.

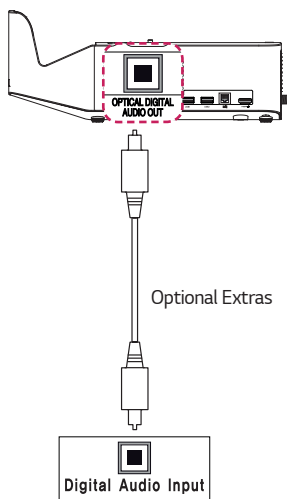

! NOTE

- Refer to the user manual of the audio device to connect.
- When connecting this product to other devices, make sure to turn off and unplug all the devices.
- The audio output of this product has wide-ranging audio bandwidth, so the receiver volume must be adjusted properly. Speakers can be damaged by unexpected high frequencies.
- Connecting the **OPTICAL DIGITAL AUDIO OUT** port of the projector to the digital audio input port of a digital amp and the audio input port of the projector to the analog audio output port of the digital amp can cause sound oscillation due to the closed loop. Remove one of the two connections to prevent this. (This also applies to home theater devices.)

MAINTENANCE

Clean your Projector to keep it in optimal condition.

Cleaning

Cleaning the Lens

If there is any dust or staining on the lens surface, you must clean the lens.

Use an air spray or a cleaning cloth to clean the lens.

To remove dust or stains, use an air spray or apply a small amount of cleaning agent onto a swab or soft cloth to lightly rub the lens.

Please be aware that liquid may flow into the lens if the product is sprayed directly onto the lens.

Cleaning the Projector Case

To clean the projector case, first unplug the power cord.

To remove dust or stains, use only a dry, lint-free, nonabrasive cloth to polish the lens.

Do not use alcohol, benzene, thinners, or other chemicals, which may damage the case.

SPECIFICATIONS

MODEL	PF1000UW (PF1000UW-NA)
Resolution (Pixel)	1920 (Horizontal) × 1080 (Vertical)
Aspect ratio	16:9 (Horizontal:Vertical)
Panel size	11.938 mm
Projection distance (Screen size)	414 mm to 686 mm (1524 mm to 2540 mm)
Ratio of upward projection	125 %
Working range of the remote control	6 m
Power consumption	100 W
AC-DC Adaptor	Manufacturer : Honor Model: ADS-110CL-19-3 190110G
	19 V  5.79 A (Adaptor Input 100-240 V @ 50/60 Hz)
Audio Output	3 W + 3 W
Reception type	ATSC / NTSC-M / 64 & 256 QAM
Reception channels	VHF 02 to 13, UHF 14 to 69, CATV 01 to 135, DTV 02 to 69, CADTV 01 to 135
External Antenna Impedance	75 Ω
Height	127.6 mm (without foot) / 128.8 mm (with foot)
Width	131.4 mm
Depth	309 mm (without tuner) / 318 mm (with tuner)
Weight	1.9 kg
USB Device	5 V, 0.5 A (Max.)

MODEL	PF1000UW (PF1000UW-NA)	
Environment Condition	Temperature	
	Operation	0 °C to 40 °C
	Storage	-20 °C to 60 °C
	Relative Humidity	
	Operation	0 % to 80 %
	Storage	0 % to 85 %

* Use only power supplies listed in the user instructions.

* Contents in this manual may be changed without prior notice due to upgrade of product functions.

HDMI (DTV) Supported Mode

Resolution	Horizontal Frequency (kHz)	Vertical Frequency (Hz)
640 x 480p	31.46	59.94
	31.50	60.00
720 x 480p	31.47	59.94
	31.50	60.00
1280 x 720p	44.96	59.94
	45.00	60.00
1920 x 1080i	33.72	59.94
	33.75	60.00
1920 x 1080p	26.97	23.97
	27.00	24.00
	33.71	29.97
	33.75	30.00
	67.43	59.94
	67.50	60.00

Supported HDMI (PC) Modes

Resolution	Horizontal Frequency (kHz)	Vertical Frequency (Hz)
640 x 350	31.46	70.09
720 x 400	31.46	70.08
640 x 480	31.46	59.94
800 x 600	37.87	60.31
1024 x 768	48.36	60.00
1152 x 864	54.34	60.05
1280 x 1024	63.98	60.02
1360 x 768	47.71	60.01
1920 x 1080	67.5	60.00

- If an invalid signal is input into the projector, it will not be displayed properly on the screen or a message such as **No Signal** or **Invalid Format** will be displayed.
- The projector supports the DDC1/2B type as the Plug and Play function (Auto-recognition of PC monitor).
- 1920 x 1080 is recommended as the best picture quality in the PC mode.

Open Source Software Notice Information

To obtain the source code under GPL, LGPL, MPL and other open source licenses, that is contained in this product, please visit <http://opensource.lge.com>.

In addition to the source code, all referred license terms, warranty disclaimers and copyright notices are available for download.

LG Electronics will also provide open source code to you on CD-ROM for a charge covering the cost of performing such distribution (such as the cost of media, shipping, and handling) upon email request to opensource@lge.com. This offer is valid for three (3) years from the date on which you purchased the product.





ABOUT LG WEBOS PROJECTOR

Image shown may differ from your projector.

Your projector's OSD (On Screen Display) may differ slightly from that shown in this manual.

Green : the buttons and the text to be displayed on the projector screen.

CONTENTS

ABOUT LG WEBOS

PROJECTOR 4

Home Tutorial 4

- Using the Home feature of the LG WebOS Projector 4

Prepare Live TV 8

- Watching TV broadcasting 8

Network Setting 8

- Network Setting 8

HOW TO OPERATE PROJECTOR 11

SIMPLINK (HDMI-CEC) 11

- Using SIMPLINK 11

Using the LG TV Plus App 13

Magic Mobile Connection 15

- Using Magic Mobile Connection 15

Using a Keyboard and Mouse 16

- Using a USB Wired/Wireless Mouse 16
- Using a USB Wired/Wireless Keyboard 16

Using a Gamepad 17

ENJOY LIVE TV 18

Live Menu 18

- Using Live Menu 18

My Channels 19

- Using My Channels 19

Guide 20

- Viewing Guide 20

Checking Program Info 21

- Viewing Program Information 21

Using Advanced Broadcast Settings 22

HOW TO USE VARIETY OF CONTENTS 23

LG Content Store 23

Creating Wish List 24

- Using My Content 24

Account Creating 25

- Creating LG Account 25

Account Management 26

- Managing your LG Account 26

Search Content 27

- Search 27
- Searching for Content 27

Use App & Contents 28

- Installing Apps 28

Watching VOD Content 29

PLAY OTHER DEVICE FILES 30**Photo & Video 30**

- Viewing Photos and Videos 30
- Photo Player 31
- Video Player 33
- Supported Video Files 35
- Cautions for Video Playback 37

Music 38

- Playing Music 38
- Using the Music Player 39

File Viewer 41

- Viewing Files 41
- Browsing File Viewer 42

Connecting USB 44

- Tips for Using a USB storage device 45

Share Smart Phone 46

- Content Share with Smartphone 46

View Smart Phone 48

- To see the Mobile Device's screen on the projector 48

Share PC 49

- What Is Content Share? 49

View PC 52

- To see the PC screen on the projector 52

BENEFITS OF SMART PROJECTOR 53**Using My Starter 53****Enjoying Internet 55**

- Using the Web Browser 55

Notifications 58

- Using Notifications 58

TOUR LIST OF SETTINGS 59**Quick Settings 59**

- To use Setting function quickly 59

Picture Settings 60**Sound Settings 67****Channels Settings 72****Network 75****General 77****Safety Settings 83****Accessibility 86****TROUBLESHOOTING 88****Abnormal Operation 88****Screen Problems 89****Sound Problems 90****PC Connection Problems 92****Photo & Video Movie Playback Problems 92****Network Connection Problems 94****LG Account Problems 95****Contents Problems 96****Internet Browser Problems 96**

ABOUT LG WEBOS PROJECTOR

Home Tutorial

Using the Home feature of the LG WebOS Projector

You can open the Home screen by pressing the  button on your remote control. You can combine frequently used apps on a single screen and use whichever you want at any time.

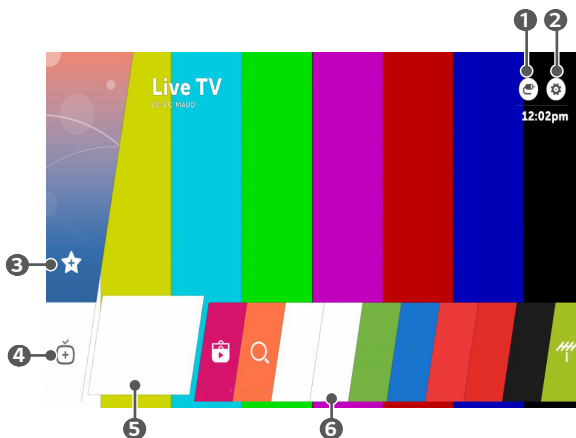

	Description
1	You can switch to another input or change your settings.
2	You can easily change the settings of your projector. Select  for advanced setup.
3	Add content you like to use, easily and quickly. (This feature is not supported in some countries. When you select the feature, you will be directed to the LG Content Store.)
4	By adding channels you like, you can check channel information and watch your desired channel easily and quickly.

	Description
5	This is a list of recently used apps. To access the list of recently used apps, select this item and then press and hold the Wheel (OK) button. You can view all the apps you used recently in the list.
6	You can run, move, and delete all the apps installed on your projector.

Using Recent List

To access the list of recently used apps, press and hold the  button on your remote control, or press and hold a recently used item on the Home screen. You can run or exit all the apps you've used recently.

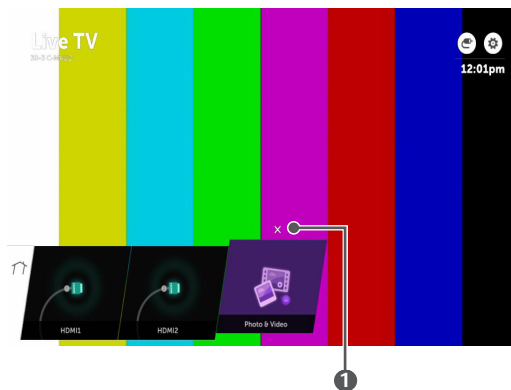

	Description
1	Exit the app.

Managing Apps

You can view a list of all apps installed on your projector, change their positions, or delete them.

ENGLISH

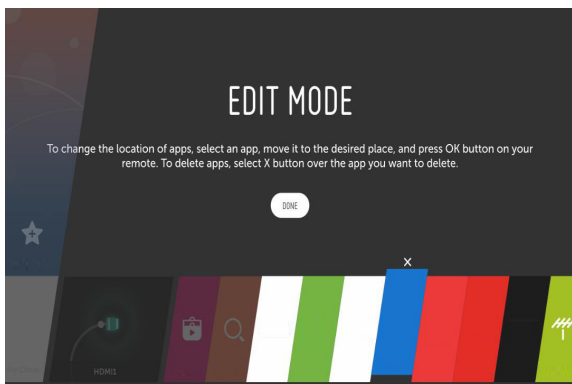

- 1 Select the app you want to edit, and press and hold the **Wheel (OK)** button on the Remote Control. This will activate the app edit mode.
- 2 To move the app to your desired position, go to the position and press the **Wheel (OK)** button. To delete an app, select the **X** above the app.
 - You can move and delete as many apps as you wish before exiting the edit mode.
 - You can also move apps with the **◀ ▶** buttons on your remote control.
- 3 When you have completed the edit, click **DONE** to exit the app edit mode.
 - Some apps cannot be edited.

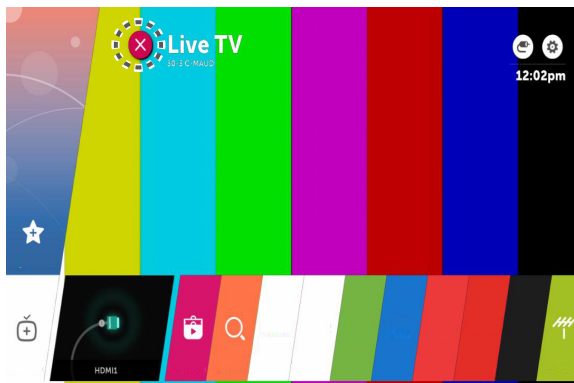

Stopping the current function



- 1 Press the  button on the remote control.
- 2 Select the application name at the top left corner of the screen by the Remote Control to display the Close icon.
- 3 Select the Close icon displayed next to the application name to quit the function in use.

Prepare Live TV

Watching TV broadcasting



- 1 Connect the broadcast antenna/cable to the projector. You may also connect a piece of equipment that can receive broadcasting such as a set-top box instead of the antenna/cable. Press the  button on the remote control. To see the details, select **Set-Top Box** from the device list that is displayed when operating the **Device Connector**.
- 2 Start the  (**Q. Settings**) →  → **Channels** → **Channel Tuning** → **Auto Tuning**. Finds and adds only channels being broadcast.

Network Setting



Network Setting

If you configure settings for the network, you can use various services such as online contents and applications.

Setting a Wired Network

- 1 Connect the LAN port of the projector and the router using a LAN cable. The router should be connected to the Internet beforehand.
- 2 Press the  (**Q. Settings**) button on the remote control and select  → **Network** → **Wired Connection (Ethernet)**. This will start the wired network connection.
 - If the router supports DHCP, the projector is automatically connected to the network when you connect the projector to the network with a LAN cable.

Setting a Wireless Network

- 1 Turn on the power of the router connected to the Internet.
- 2 Press the  (Q. **Settings**) button on the remote control and select  → **Network** → **Wi-Fi Connection**. This will start the Wireless network connection.
- 3 When the network search is complete, the list of networks available for connection is shown.
- 4 Select a network to connect. If your Wireless Router is password protected, enter the password configured for the router.

Network Setting Warnings





- Use standard LAN cable (connect to Cat5 or higher with RJ45 connector, 10 Base-T, or 100 Base TX LAN port).
- Resetting the modem may fix some network connection problems. Turn the power OFF, disconnect and reconnect it, and then turn the power on to solve the problem.
- LG Electronics is not responsible for any network connection problems or any faults, malfunctions, or errors caused by network connection.
- The network connection may not work properly because of network settings or the Internet service provider.
- DSL service must use a DSL modem; and cable service must use a cable modem. Since only a limited number of network connections may be available, projector network setting may not be used depending on the contract with Internet service provider. (If the contract does not allow more than one device per line, only the already-connected PC may be used.)
- A wireless network can experience interference from other devices that use the 2.4 GHz frequency (wireless phone, Bluetooth device, or microwave oven). Although interference can also happen when using the 5 GHz frequency, it is less likely to occur.
- The wireless environment can make wireless network service run slowly.
- Failure to turn off all local home networks may cause excessive traffic on some devices.
- The access point device must support wireless connections and wireless connection feature must be enabled on the device to have AP (access point) connection. Contact the service provider for availability of wireless connections on the access point.
- Check SSID and security settings of the AP. Refer to the appropriate documentation for SSID and security settings of the AP.
- Invalid settings of network devices (wired/wireless line sharer, hub) can cause the projector to operate slowly or not operate properly. Install the devices correctly according to the appropriate manual and network.
- The connection method may differ depending on the AP manufacturer.

HOW TO OPERATE PROJECTOR

SIMPLINK (HDMI-CEC)

Using SIMPLINK

You can conveniently control and use various multimedia devices connected through HDMI with the projector's remote control.

- 1 Connect the SIMPLINK HDMI Output port to the projector's HDMI IN port with an HDMI cable.
 - 2 Press the  (**Q. Settings**) button on the remote control and select  → **General** → **SIMPLINK (HDMI-CEC)**.
 - 3 Set **SIMPLINK (HDMI-CEC)** to **On**.
 - 4 Configure the **Auto Power Sync** settings to **On** or **Off**. (If **Auto Power Sync** is set to **On**, turning on a SIMPLINK-linked device will turn the projector on. When you turn off the projector, the device will also be turned off.)
 - 5 Turn on the connected device. When the projector automatically connects to the device, the input will switch. If the device is not automatically connected to the projector, click the  (**INPUT**) button.
- This feature works only with devices with the  logo. Check for the SIMPLINK logo on the external device. There may be a problem using the device if the device does not meet the required specifications.
 - A high-speed HDMI® cable with CEC (Consumer Electronics Control) function is required to use SIMPLINK. Pin 13 of the high-speed HDMI® cable is used for data transfer between devices.
 - If you want to output sound to the external audio equipment connected through the HDMI cable, set **SIMPLINK (HDMI-CEC)** to **On**.

Supported SIMPLINK Functions

- **Instant Play**

When you start a multimedia device, you can immediately watch content from the device on the projector without having to control anything.

- **Controlling devices with the projector remote control**

Enables the user to control multimedia devices with the projector remote control to watch content.

- **Main Power Off**

If **Auto Power Sync** is set to **On** in the **SIMPLINK (HDMI-CEC)** settings and the projector is turned off, the devices connected to your projector via SIMPLINK will also be turned off. Likewise, your projector will be turned off if you turn off a device connected to your projector via SIMPLINK.

- This feature is only available in certain devices.



- **Main Power On**

If **Auto Power Sync** is set to **On** in the **SIMPLINK (HDMI-CEC)** settings, turning on a SIMPLINK-linked device will turn the projector on.

- If **SIMPLINK (HDMI-CEC)** is set to **Off**, **Auto Power Sync** can not be set to **On**.

Using the LG TV Plus App

You can control the functions of your projector by using the app installed on your smart device.

- You can watch TV shows, movies, and recommended content. Also, you can make a wishlist. (This feature is available in certain countries only.)
 - You can search for any content you want. (This feature is available in certain countries only.)
 - The text input function is supported, so you can enter text easily. (Text cannot be entered on some screens.)
 - You can control your projector's Magic Remote Pointer using the Touch Pad on the app.
- 1 Download LG TV Plus app from the Apple App Store or the Google Play Store, depending on the OS of each smart device.
 - 2 Press the  (Q. **Settings**) button on the remote control and select  → **Network**.
 - 3 Set **LG Connect Apps** to **On**.
 - 4 Connect the projector and your smart device on the same Wi-Fi network.
 - 5 Launch the LG TV Plus app on your smart device.
 - 6 Tap the Start button to scan for projectors that can be connected to your smart device.
 - 7 Select the projector you want from the list of search results. A PIN code appears on the projector screen.
 - 8 Enter the PIN code in the LG TV Plus app to pair your smart device with the projector.
 - 9 You can tap the buttons on your smart device's screen to control the projector.



	Description
①	You can use various apps installed on your projector.
②	You can control the TV channels, volume, etc. remotely.
③	You can move the pointer on the projector's screen just like using the Magic remote.

- The app's screen and functionality are subject to change without prior notice.
- The functions require a network connection.
- The supported functions may vary depending upon the country.

Magic Mobile Connection

Using Magic Mobile Connection

Magic Mobile Connection lets you share and enjoy the content stored on people's smart devices through your projector.

- It is recommended that your Android smart devices run Lollipop or later versions of Android.

Connecting a Smart Device with Magic Mobile Connection

Set up a connection following the guide below:

- 1 Install the **LG TV Plus** app on the smart device.
 - 2 Connect both your projector and the smart device to the same network.
 - 3 Run the **LG TV Plus** app and set up a connection to your projector following the instructions shown on the screen.
 - 4 Press the  button, and a list of connected smart devices will appear on the right side of the screen.
 - 5 Select your desired smart device.
- Android smart devices will automatically attempt to reconnect when they enter the network zone after the initial connection has been established.

Sharing Content with Magic Mobile Connection

You can share and enjoy the content stored on your smart device through your TV.

- 1 Run the **LG TV Plus** app installed on your smart device.
 - 2 Set up your desired content on your projector.
- Some features may not be available depending on whether or not you have logged in as a member in the **LG TV Plus** app.
 - Supported features may vary depending on the country.
 - Supported features may vary depending on the version of your smart device's operating system.

Using a Keyboard and Mouse

Using a USB Wired/Wireless Mouse

Connect your mouse to the USB port. Use the mouse to move the pointer on the projector screen and select the menu you want.

Mouse Left Button

OK Button on Magic Remote

Mouse Wheel Button

Wheel Button on Magic Remote

- The right button and the special buttons on the mouse do not work.
- When using a wireless USB mouse/keyboard, the experience may be affected by the distance and wireless condition.

Using a USB Wired/Wireless Keyboard

Connect your keyboard to the USB port. You can enter text with the connected keyboard device.

- It is not possible to enter text on some screens.
- It is recommended that you use a product that has been tested for compatibility with LG projectors.
 - LOGITECH K360, LOGITECH K400, LOGITECH K750, LG Electronics MKS-1200
- You can change the input language by pressing the language switch key or the right Alt key. It can also be changed by pressing the Ctrl key and the Space key at same time.
- Wireless USB keyboard use may be affected by the usage range and the wireless environment.
- To enter text in the text field, use the on-screen keyboard on your projector screen or a USB keyboard.

Using a Gamepad

Connect your gamepad to the USB port on the projector if the game requires a gamepad.



- It is recommended that you use a gamepad that has been tested for compatibility with LG projectors.
 - LOGITECH F310, LOGITECH F510, LOGITECH F710, LOGITECH Rumblepad 2, LOGITECH Cordless Rumblepad 2, LOGITECH Dual Action Gamepad, MICROSOFT Xbox 360 Controller (cable), SONY Playstation(R)3 Controller

ENJOY LIVE TV

Live Menu

Using Live Menu

You can use the relevant features with ease when watching TV broadcasts.

- 1 Run **Live TV** by pressing .
- 2 Move the Magic Remote's pointer to the right side of the projector screen. You can also press the  button on your Remote Control to see the Live Menu.

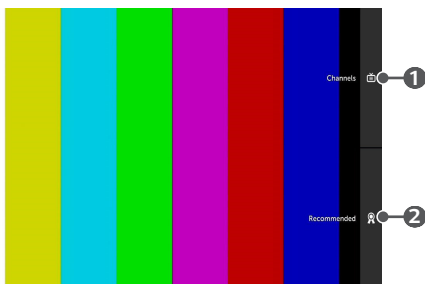

	Description
①	View a list of broadcast content that is currently being broadcast.
②	Get channel and program recommendations based on your viewing history.

- The channels displayed in Channel List are a configuration of channels provided by the broadcast service provider. Therefore, if the broadcast service provider has changed its channel configuration without notice, the channels displayed in Channel List may differ from the actual TV channels.
- Because channel information displayed in Channel List includes information provided by external Electronic Program Guide (EPG) providers, it may differ from the actual TV channels.
- You must have a network connection with Internet access to use the Program Recommendation feature in Recommended List.
- To receive proper recommendation services, you need to set up your network, region and auto tuning.
- Options may vary depending on the country.

My Channels

Using My Channels

If you add channels to **My Channels**, you can check and watch the programs being broadcast in the added channels of any app.

Adding a Channel

- 1 Press the  button on your remote control.
 - 2 Select **My Channels** at the bottom left of the screen.
 - 3 Selecting **Add Channel** displays a list of channels.
Select the channel you want to add from the channel list.
 - You can continue to add other channels to **My Channels** in the same way.
- To add set-top box channels, you need to set **Setup universal control** in **Device Connector** and use a Magic Remote. (This feature is available on certain models only.)
 - To switch to a set-top box channel, you need to select among the added channels using your Magic Remote. (This feature is available on certain models only.)
 - If you select a channel already added in **My Channels**, you can access the channel in other apps as well.
 - You can move/delete added channels in the same way as when you manage apps.

Guide

Viewing Guide

You can view programs and the schedule of each program.

- 1 Press the  button on the remote control.
- 2 You can launch the **Guide** application.

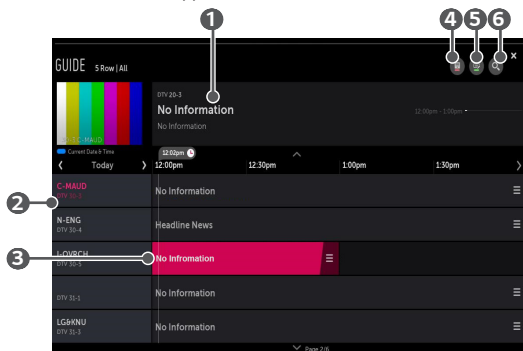

	Description
1	You can view information about the program you are currently watching as well as the focused program information.
2	Displays the information of the broadcasting company.
3	Go to the program you want and then press the  Wheel (OK) . You can watch a program. You can also schedule to watch.
4	Sets the filter.
5	Launch CHANNEL MANAGER .
6	Launch SEARCH .

- To view information on online channels and broadcasting, you must set up your location, network, and channels.

Viewing Set-Top Box Guide

After connecting the Set-Top Box, you can view programs and the schedule of the Set-Top Box and use the Magic Remote.

- This function is available on certain models or in certain countries only.

Checking Program Info

Viewing Program Information

Information about the program you are currently watching, the current time, etc. are displayed.

- 1 Click the channel banner that appears when you change channels.

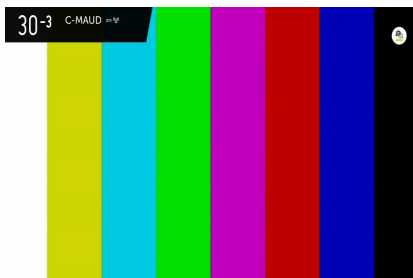

- 2 You can view detailed information about the program you are currently watching.

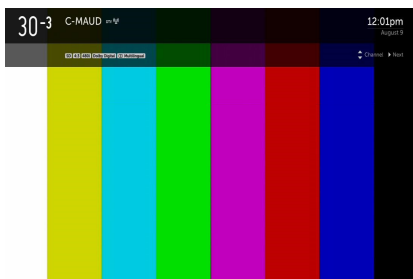

Using the \triangle ∇ \triangleleft \triangleright buttons on your remote control, you can view information about upcoming programs or other channels without changing the channel.

- You can view broadcast information about other channels using the \triangle ∇ buttons.
- You can view broadcast information about the channel you are currently watching using the \triangleleft \triangleright buttons.

Using Advanced Broadcast Settings

If the broadcast you are watching contains **Closed Caption**, **AUDIO LANGUAGE**, or **Multi Audio** information, you can use such features.

- 1 Press the  **Wheel (OK)** button on your remote control.
- 2 Select your desired feature in the top of the screen and set the feature to your desired value.



	Description
①	You can set Closed Caption .
②	You can set AUDIO LANGUAGE . <ul style="list-style-type: none"> • Only available with digital broadcasts.
③	You can set Multi Audio . <ul style="list-style-type: none"> • Only available with analog broadcasts.

- Available features may vary depending on the broadcast signal.

HOW TO USE VARIETY OF CONTENTS



LG Content Store

You can quickly and conveniently browse for **TV Shows**, **Movies**, and more to watch immediately.

You can also download and use apps from various categories such as education, entertainment, lifestyle, news, and games.

1 Press the  button on the remote control.

2 Launch the **LG Content Store** application.

- This feature is only available in certain countries.
- Features may be limited in certain countries.
- Content may differ depending upon the country.
- Exercise caution when in used by children. Children may have access to inappropriate online content through this product.
- You can block inappropriate online content by restricting access to some apps such as the Internet browser. Restrictions can be set in  (**Q. Settings**) →  → **Safety**.

Recommended Content on the Main Screen

The main screen of the **LG Content Store** shows the most popular content for each category. Select any content to view its details.

- Internet connection is required to use this feature.

Creating Wish List

Using My Content



By adding your desired content to **My Content**, you can use the content easily and quickly anytime.

- 1 Press the  button on your remote control.
- 2 Select **My Content** in the top left of the screen.
- 3 Select **Add Content**.
- 4 Search for content.
- 5 Select your desired content from the search results to add it to **My Content**.
 - You can also select from among recommended content shown under the search box and directly add it to **My Content**.
 - This feature is only available in certain countries.
 - The type of content you can add to **My Content** may vary depending on the country.
 - You must have a network connection to use this feature.
 - You can move/delete added content in the same way you manage apps.
 - Some of the content services added to **My Content** may not be available if the service has been terminated due to the provider's circumstances.

Account Creating

Creating LG Account



In **Account Management**, you can use your email address to create a new LG account.

- 1** Press the  (**Q. Settings**) button on the remote control and select  → **General** → **Account Management**.
- 2** Select **CREATE ACCOUNT**. Read and accept the Terms of Service.
- 3** Enter an ID and a password. Your ID must be your email address.
- 4** Enter your birthday.
- 5** Select **OK**. Go to your email to verify your email address. Please verify your email before the time expires.
- 6** Log in with your new account to start using the service.
 - Internet connection is required to create an account.
 - Required information may vary depending upon the country.
 - Existing IDs that do not use an email address can be converted to your email address.
 - You can log in with your Facebook or Google account. (Features other than login may not be available.)
 - You may be restricted from the service depending upon your age.

Account Management

Managing your LG Account

You can manage the information of your LG account.

- 1 Press the  (**Q. Settings**) button on the remote control.
- 2 Go to  → **General** → **Account Management** to log in.

Personal Information

You can view or edit your information of the account currently logged in.

You can change the password or press **EDIT** to edit your personal information.

Search Content

Search

Search allows you to find and use a variety of content and information. You can search for files, including image, video, audio, and recording files.

Searching for Content

- 1 Run **Search** by pressing the  (**SEARCH**) button on your remote control.
- 2 Search for a variety of content and information by typing in your desired search terms.

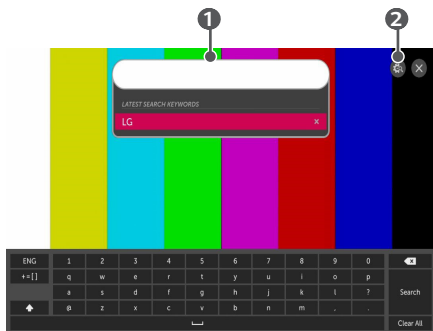

	Description
1	Enter your desired search term.
2	Change the settings of the features provided by Search . <ul style="list-style-type: none"> • Some apps provide a feature that lets you search within your projector. If you run a search in such apps, the search will be carried out in Search.

- Search results may vary depending on the channel, region, network settings, and whether you have agreed to the terms and conditions.

Use App & Contents

Installing Apps

You can use your LG account to install various apps on your projector.

- 1** Press the  button on the remote control.
- 2** Launch the **LG Content Store** application.
- 3** Select your desired category from the categories shown at the top of the screen. The list of available apps in the selected category will be shown.
- 4** Select an app to set up from the list.
- 5** Read the details of the app and then press **Install**.
- 6** When the installation is complete, you can run the app immediately.
 - Available categories may vary depending on the country or service status.
 - If the storage on your projector is insufficient, you can install the apps by connecting an external memory device.
 - Some USB storage devices may not be supported or may not work properly.
 - USB drivers containing apps from other LG TVs or LG Projectors may not be used.

Watching VOD Content

You can immediately enjoy dramas, movies, and more with real-time streaming.

- 1 Press the  button on the remote control.
- 2 Launch the **LG Content Store** application.
- 3 Select your desired category from the categories shown at the top of the screen, such as **TV Shows** and **Movies**. The list of available content in the selected category will be shown.
- 4 Select an item from the list.
- 5 Read the details of the content and then press **Watch Now**.
- 6 Select a playback option. An app may be required to play the content with the selected playback option. If not installed, install the app to play the content.
- 7 The content is played using the selected option.
 - This feature is only available in certain countries.
 - Available categories may vary depending on the country or service status.
 - Adult authentication is required for playing adult content.

PLAY OTHER DEVICE FILES

Photo & Video

Viewing Photos and Videos

You can view photos and videos using the **Photo & Video** app.

- 1 Press the  button on your remote control.
- 2 Launch the **Photo & Video** application.
- 3 Select your desired storage device.
- 4 Select and view your desired photo or video.

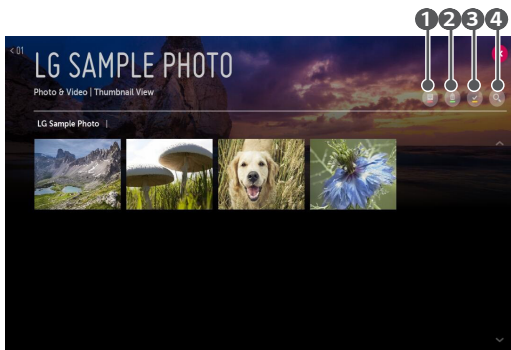

	Description
1	Select your desired type of content and viewing method.
2	Select and delete your desired content. (You cannot delete files that are shared from other devices.)
3	Select the content you want to play. You can only select the same type of content as you first selected.
4	Launch Search .

- Certain content may not be displayed on the list if the number of all content exceeds 40,000.

Photo Player

Selecting a photo in the **Photo & Video** app runs the photo player. You can view your saved photos.

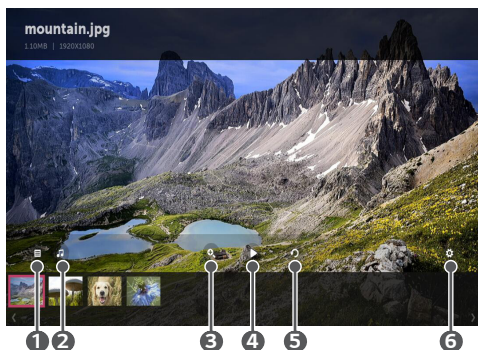

	Description
①	Returns to the entire content list.
②	You can play background music by running the music player.
③	You can zoom the photos in/out.
④	Starts the slide show.
⑤	Rotates photos.
⑥	You can set the size of a photo or change the speed and effect of a slide show.

Supported Photo Files

File type	Format	Resolution
.jpeg .jpg .jpe	JPEG	Minimum: 64 x 64 Maximum Normal Type: 15360 (W) x 8640 (H) Progressive Type: 1920 (W) x 1440 (H)
.png	PNG	Minimum: 64 x 64 Maximum: 5760 (W) x 5760 (H)
.bmp	BMP	Minimum: 64 x 64 Maximum: 1920 (W) x 1080 (H)

Video Player

Selecting a video in the **Photo & Video** app runs the video player. You can view your saved videos.

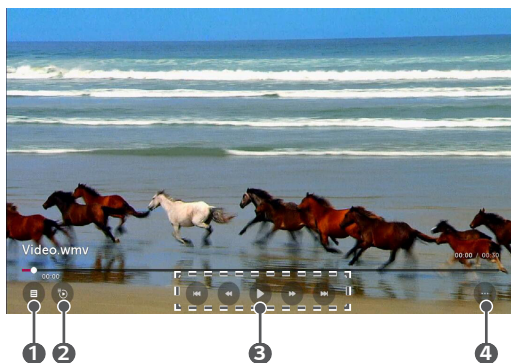

	Description
1	Returns to the entire content list.
2	You can select other content by displaying the playlist while watching a video.
3	You can control basic video playback functions.
4	You can set additional options.

ADDITIONAL OPTIONS



	Description
①	You can change subtitle settings.
②	You can set audio tracks.
③	You can set continue watching to resume playing from the last viewed scene.
④	You can set continuous playback. If continuous playback is set, the next video is automatically played after the playback of a video is over.
⑤	Returns to the basic operation screen.

Supported Video Files

Maximum data transfer rate:

- Full HD video
 - H.264 1920 x 1080@60P BP/MP/HP@L4.2 40 Mbps
 - HEVC 1920 x 1080@60P MP@L4.1, Main10 Profile@L4.1 40 Mbps

Supported external subtitles:

*.smi, *.srt, *.sub (MicroDVD, SubViewer 1.0/2.0), *.ass, *.ssa, *.txt (TMPlayer), *.psb (PowerDivX), *.dcs (DLP Cinema)

Supported embedded subtitles format:

- Matroska (*.mkv) : Sub Station Alpha (SSA), Advanced Sub Station Alpha (ASS), SRT
- MP4 (*.mp4) : Timed Text

Supported video codecs

Extension	Codec	
.asf .wmv	Video	VC-1 Advanced Profile (except for WMVA), VC-1 Simple and Main Profiles
	Audio	WMA Standard (except for WMA v1/ WMA Speech)
.avi	Video	Xvid (except for 3 warp-point GMC), H.264/AVC, Motion Jpeg, MPEG-4
	Audio	MPEG-1 Layer I, II, MPEG-1 Layer III (MP3), Dolby Digital, LPCM, ADPCM, DTS
.mp4 .m4v .mov	Video	H.264/AVC, MPEG-4, HEVC
	Audio	Dolby Digital, Dolby Digital Plus, AAC, MPEG-1 Layer III (MP3)
.3gp .3g2	Video	H.264/AVC, MPEG-4
	Audio	AAC, AMR-NB, AMR-WB
.mkv	Video	MPEG-2, MPEG-4, H.264/AVC, VP8, VP9, HEVC
	Audio	Dolby Digital, Dolby Digital Plus, AAC, PCM, DTS, MPEG-1 Layer I, II, MPEG-1 Layer III (MP3)
.ts .trp .tp .mts	Video	H.264/AVC, MPEG-2, HEVC
	Audio	MPEG-1 Layer I, II, MPEG-1 Layer III (MP3), Dolby Digital, Dolby Digital Plus, AAC, PCM
.mpg .mpeg .dat	Video	MPEG-1, MPEG-2
	Audio	MPEG-1 Layer I, II, MPEG-1 Layer III (MP3)
.vob	Video	MPEG-1, MPEG-2
	Audio	Dolby Digital, MPEG-1 Layer I, II, DVD-LPCM

Cautions for Video Playback

- Some user-created subtitles may not work properly.
- A video file and its subtitle file must be located in the same folder. For subtitles to be displayed properly, make sure that the video file and the subtitle file have the same name.
- Subtitles on a Network Attached Storage (NAS) device may not be supported depending on the manufacturer and model.
- Streams that include Global Motion Compensation (GMC) and Quarterpel Motion Estimation (Qpel) are not supported.
- Playable file sizes may vary depending on the encoding conditions.
- Only Window Media Audio V7 and later are supported.
- The AAC main profile is not supported.
- Video files created by some encoders may not be played.
- Video files in a different format than specified may not be played properly.
- Video files stored on a USB storage device that does not support High Speed may not be played properly.
- DTS codecs are supported only for playbacks of USB and HDMI video files.

Music

Playing Music

You can listen to music by using the **Music** app.

- 1 Press the  button on your remote control.
- 2 Launch the **Music** application.
- 3 Select your desired storage device.
You can select your desired songs from all of your storage devices and add them to **MY PLAYLIST**.
- 4 Select your desired music content and enjoy it.

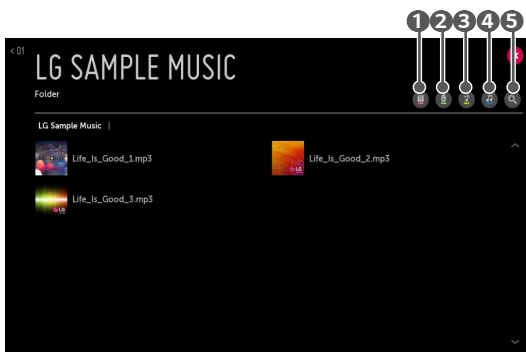



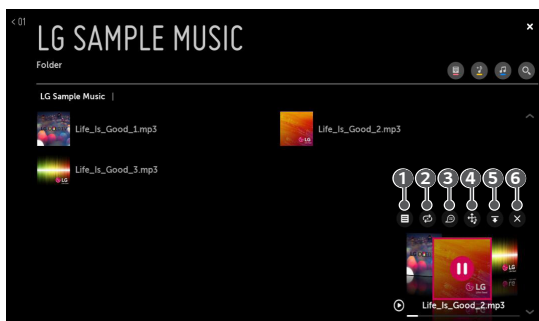

	Description
1	Select the desired type of content list.
2	Select and delete content. (Files shared from other devices cannot be deleted.)
3	Select content and add it to MY PLAYLIST .
4	Open the music player.
5	Launch SEARCH .

- If the number of all content is more than 5,000, some content may not be listed up.

Using the Music Player



	Description
①	View your music list in the Music app and select songs to play.
②	You can set repeat playback and random playback.
③	You can listen to music with the screen turned off.
④	You can change the position of the music player.
⑤	You can minimize the music player.
⑥	This feature closes the music player.

- Reopen your music player by pressing the   **VOL** buttons on your remote control.
- You may not be able to use the music player for some features.
- You can also run the music player as follows:
 - Select  in the **Music** app.
 - Select  while viewing photos in the **Photo & Video** app.

Audio Format

File Format	Item	Info
.mp3	Bit rate	32 kbps ~ 320 kbps
	Sample freq.	16 kHz ~ 48 kHz
	Support	MPEG 1, MPEG2
	Channels	mono, stereo
.wav	Bit rate	-
	Sample freq.	8 kHz ~ 48 kHz
	Support	PCM
	Channels	mono, stereo
.ogg	Bit rate	64 kbps ~ 320 kbps
	Sample freq.	8 kHz ~ 48 kHz
	Support	Vorbis
	Channels	mono, stereo
.wma	Bit rate	128 kbps ~ 320 kbps
	Sample freq.	8 kHz ~ 48 kHz
	Support	WMA
	Channels	up to 6 ch

- The number of supported channels may vary depending upon the sample frequency.

File Viewer

Viewing Files

You can see document files stored on a connected device.

- 1 Press the  button on your remote control.
- 2 Launch the **File Viewer** application.
- 3 Select your desired storage device.
- 4 Select and view your desired document file.

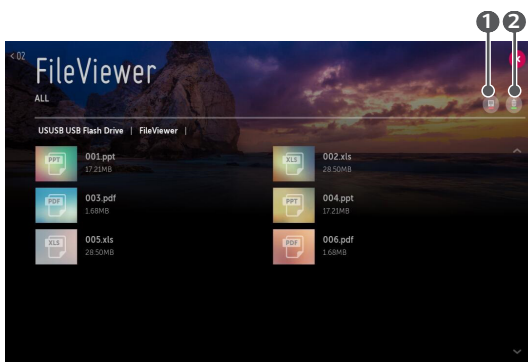

	Description
1	Select your desired type of content and viewing method.
2	Select and delete your desired content. (You cannot delete files that are shared from other devices.)

- Certain content may not be displayed on the list if the number of all content exceeds 40,000.

Browsing File Viewer

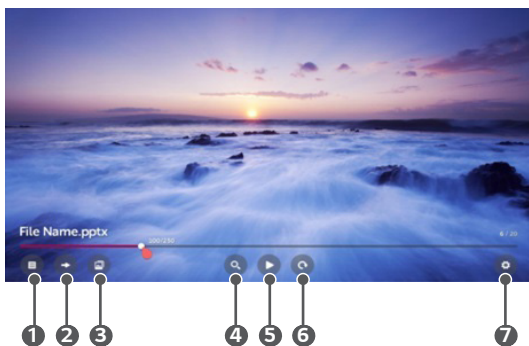

	Description
1	Returns to the entire content list.
2	Moves to the page you specify.
3	Sets the slide show.
4	Enlarges or reduces the document.
5	Starts the slide show.
6	Rotates the document.
7	Sets up the options of File Viewer.

Supported File Formats

XLS, XLSX, DOC, DOCX, PPT, PPTX, TXT, PDF, HWP

Microsoft Office 97/2000/2002/2003/2007/2010/2013/2016 version

Adobe PDF 1.0/1.1/1.2/1.3/1.4 version

Hangul 2007 version



- File Viewer realigns a document, so it may look different from what is displayed on a PC.
- For documents that include images, the resolution may look lower during the realigning process.
- If the document is large or has many pages, it may take longer to load.
- Unsupported fonts may be replaced by other fonts.
- The file viewer may not open for Office documents that contain many high resolution images. In that case, reduce the image file size, save it on a USB storage device and run the file viewer again or connect your PC to the projector and open the file on your PC.

Connecting USB

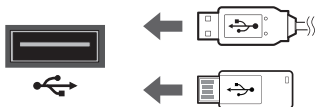
Connect a USB storage device (USB HDD, USB Flash Drive) to the USB port on the projector to enjoy the content files stored on the USB storage device on your projector.



Tips for Using a USB storage device

- A USB storage device that has a built-in automatic recognition program or uses its own driver might not be recognizable.
- Some USB storage devices may not be supported or may not work properly.
- If you use a USB extension cable, the USB storage device may not be recognized or may not work properly.
- Please use only USB storage devices formatted with the FAT32 or NTFS file system provided by Windows OS.
- It is recommended that you use an external USB HDD with a rated voltage of 5 V or less and a rated current of 500 mA or less.
- It is recommended that you use a USB hub or hard disk drive with a power supply. (If the power supplied is not sufficient, the USB storage device may not be detected properly.)
- It is recommended that you use a USB flash drive of 32 GB or less or a USB HDD of 2 TB or less.
- If a USB HDD with power-saving function does not work, turn the hard drive off and on again to make it work properly. See the owner's manual for the USB HDD for more information.
- Data on a USB storage device may be damaged, so it is recommended that you back up any important files. Users are responsible for data management. The manufacturer bears no responsibility.
- Select the connected USB from **INPUTS** and select the **EJECT** button to disconnect the USB storage device.
If you disconnect the USB storage device without selecting **EJECT**, an error may occur in your projector or storage device.
You can open **INPUTS** by selecting  (**INPUT**) → **All Inputs**.
- For more information on other connection methods, go to  → **Device Connector**.
- Select the connected USB from **INPUTS** and select the **FORMAT** button to format the USB storage device. After format, all the data of USB storage device will be deleted and formatted as NTFS or FAT32 file system.
- When connecting a USB storage device, a random file/folder can be created to provide Smart projector services such as the saving and retrieving of thumbnail images.

Share Smart Phone

Content Share with Smartphone

Content Share allows you to enjoy videos, music, and photos saved on your Smartphone that is connected to the same network.

Connecting to a smartphone with your projector

- 1 Press the  button on the remote control.
- 2 Launch the **Device Connector** application.
- 3 Select the **Smartphone**.
- 4 Follow instructions in **Device Connector**.



Matters that require special attention during Content Share

- Check your network settings if the Content Share option does not work properly.
- May not work properly on a wireless network. It is recommended that you connect to a wired network.
- May not work properly depending upon the network environment.
- If multiple display devices are connected to one device, the content may not be played properly depending upon server performance.
- The Content Share function may not be supported for a router that does not support multi-cast. For more information, refer to the user guide that came with your router or contact the manufacturer.
- To watch the 1080p video through Content Share function, a router that uses 5 GHz frequency is required. If a 2.4 GHz router is used, the video may not play properly.
- Captions are only supported on some connected devices.
- When a subtitle file is added later, disable the shared folder and then enable it again.
- The DRM files in the connected device will not play.
- Even for the file format supported by the projector, the supported file format may differ depending upon the connected device environment.
- If there are too many folders or files in a folder, it may not work properly.
- The information on the file imported from the connected device may not be displayed correctly.
- Depending upon the encoding, some streams may not play in Content Sharing mode.

View Smart Phone

To see the Mobile Device's screen on the projector

- 1 Press the  button on your remote control.
 - 2 Launch the **Screen Share** application.
 - 3 Enable Miracast mode on the mobile device.
 - 4 Your projector will be displayed in the list of available devices in the menu.
 - 5 Select your projector to start connecting.
 - 6 A message saying Connecting... will appear to start the connection.
 - 7 When the connection is established, the projector will display the screen of the connected device.
- Always update your device to be connected to your projector to the latest OS version for a reliable connection.
 - A non-LGE device might not connect even when it is detected.
 - Connect the device to a 5 GHz router because the performance may be affected by your wireless environment.
 - The response rate may vary, depending upon the user's environment.
 - It differs among devices. For more information on the device you want to connect to, refer to its user guide.
 - Turn **LISTEN MODE** to **On** after launch the **Screen Share** app. You can connect the device without starting the **Screen Share** app.
 - **LISTEN MODE** may affect the performance of your wireless connection when connected to an AP. If there are any issues related to wireless performance, it is recommended to turn off **LISTEN MODE**.
 - If connection fails repeatedly, turn off the projector and the device you want to connect to, then turn them back on and try again.

Share PC

What Is Content Share?

Content Share allows you to enjoy videos, music and photos saved on your PC.

Play the content with sharing software on the PC

If the computer operating system is Windows 7 or Windows 8, you can play music, video, or photos on your projector without installing an additional program.

- 1** Configure the projector and PC on the same network. Also configure the network on the PC installed with Windows 7 or Windows 8.
 - 2** Right-click the desired music, video, or photo file, and select the model using the Play To function provided in Windows 7 or Windows 8 to play what is selected.
To play on other devices like your mobile phone, refer to the relevant user guide.
- Even when multiple projectors or devices are connected, the selected file is played through only one device. The playback rate may vary depending on the network connection.

Use the SmartShare PC Software to play the content saved on the PC

You can use SmartShare PC Software to connect the music/videos/photos saved on the PC to your home network and play them on your projector.

- 1 Configure the projector and PC installed with SmartShare on the same network.
 - The SmartShare service is only available when the projector and server PC are connected to a single router.
- 2 Download and install SmartShare PC Software from the LG website. Before installation, exit all programs running on the PC, such as a firewall or an anti-virus software.
- 3 Run SmartShare PC Software and configure the share settings.
- 4 Shared videos and photos are played from the **Photo & Video** app on the projector. Shared music files are played from the **Music** app on the projector.
 - The server should be running in order to watch the shared file on your projector.
 - You can check the website information from  → **Device Connector** → **PC** → **CONTENT SHARE**.
 - For information on how to use the SmartShare PC Software, refer to the software's help section.

Matters that require special attention during Content Share

- Check your network settings if the Content Share option does not work properly.
- May not work properly on a wireless network. It is recommended that you connect to a wired network.
- If multiple display devices are connected to one device, the content may not be played properly depending on server performance.
- May not work properly depending on the network environment.
- To watch the 1080p video through Content Share function, a router that uses 5 GHz frequency is required. If a 2.4 GHz router is used, the video may not play properly.
- The Content Share function may not be supported for a router that does not support multi-cast. For more information, refer to the user guide that came with your router or contact the manufacturer.
- Captions are only supported on some connected devices.
- SmartShare PC Software is recommended for reading captions.
- When a subtitle file is added later, disable the shared folder and then enable it again.
- The DRM files in the connected device will not play.
- Even for the file format supported by the projector, the supported file format may differ depending on the connected device environment.
- If there are too many folders or files in a folder, it may not work properly.
- The information on the file imported from the connected device may not be displayed correctly.
- Depending upon the encoding, some streams may not play in Content Sharing mode.

View PC

To see the PC screen on the projector

Connect wireless

- 1 Press the  button on the remote control.
 - 2 You can launch the **Screen Share** application.
 - 3 Start **Intel® WiDi** on the device you want to connect.
 - 4 Your projector will be displayed in the list of available devices.
 - 5 Select your projector to request a connection, and a message asking you to enter an 8-digit PIN will appear on the projector screen.
 - 6 Enter the PIN and select **Connect**.
 - 7 After the connection is established, the projector will display the screen of the connected device.
- Always update your device to be connected to your projector to the latest OS version for a reliable connection.
 - When connecting via **Intel® WiDi**, place the device close to the projector.
 - **Intel® WiDi** allows connections without a wireless router. For the best possible performance, connect your device to a 5 GHz router.
 - This feature is available only on a PC that supports Intel® WiDi.
 - It supports the connection over the Intel® WiDi 3.5 version.
 - The response rate may vary, depending upon the user's environment.
 - It's different from Windows version. For more information on the device you want to connect to, refer to its user guide.
 - Turn **LISTEN MODE** to **ON** after launching the **Screen Share** app. You can connect without starting the **Screen Share** app.
 - If you turn on **LISTEN MODE**, it may affect the performance of your wireless connection when connected to an AP. If there are any issues related to wireless performance, turn off **LISTEN MODE**.
 - For more information, refer to the **Screen Share** app.
 - If connection fails repeatedly, turn off the projector and the device you want to connect to, then turn them back on and try again.

Connect wired

Connect the PC with projector by HDMI cable.



BENEFITS OF SMART PROJECTOR

Using My Starter

My Starter lets you view information through your projector, such as the current time, weather, and schedules you have added to your smart device.

- By setting up **My Starter** on your projector or in the **LG TV Plus** app, you can make **My Starter** run automatically at a specified time with your projector being turned on.
- Some features are available only after you install the **LG TV Plus** app on your smart device.

Setting Up on Your projector

- 1 Press the  (**Q. Settings**) button on your remote control.
- 2 Select  → **General** → **Timers** → **Timer Power On** → **Set My Starter** and set the option to **On**.

Setting Up in the LG TV Plus App

- 1 Download the **LG TV Plus** app from the app store of your smart device.
- 2 Connect your projector and smart device to the same network.
- 3 Run the **LG TV Plus** app installed on your smart device.
- 4 Select **My Starter** in the **LG TV Plus** app and set the options.

Viewing a Schedule with My Starter

Set up schedule sharing with your projector in the **LG TV Plus** app following the instructions, and then you can view the schedules added to your smart devices on your projector.

- 1 Press the  button.
- 2 Run **My Starter** by selecting the time displayed in the upper right corner of the screen.

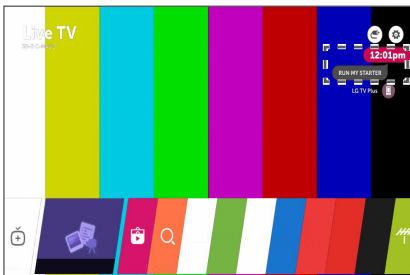

- If there is no time displayed, set up the time for your projector.
- If multiple smart devices have been set up to share schedules with your projector, the schedule on the last smart device set up for schedule sharing is provided.
- You can use schedule sharing without configuring **Set My Starter**.

Enjoying Internet

Using the Web Browser

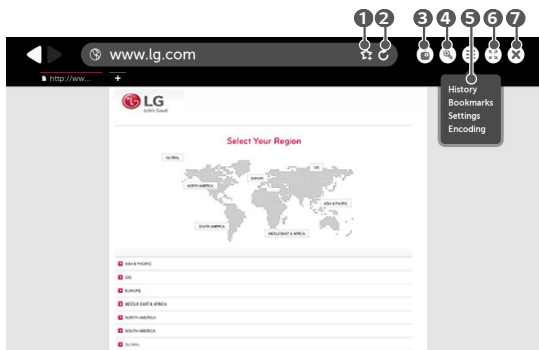

You can enter the website when you input the web address on the URL bar. If you input the search word, it will find the information about search word base on the search engine.

- 1 Press the  button on the remote control.
- 2 Launch the **Web Browser** application.



	Description
1	You can add the current page to the Home screen, or add or delete the current page in Bookmarks . (A page added to the home screen can only be deleted on the home screen. In this case, it is not deleted from Bookmarks .)
2	Reloads the current page.
3	You can turn on/off Mini TV.
4	Zooms in or out of the screen.

	Description
5	<p>History : You can open or delete the history list.</p> <p>Bookmarks : You can open or delete the bookmark list.</p> <p>Settings : You can configure simple settings for the browser.</p> <p>Encoding : You can change the language when the content is not properly displayed on the web page.</p>
6	You can use the browser in full screen mode. To go back to the original screen, use the Remote Control to move the pointer to the top of the screen. Exit Full Screen will display.
7	Exit the Web Browser .

- The **Web Browser** supports only HTML5 media, it does not support Flash Plug-in.
- The **Web Browser** does not support plug-in installation.
- On the **Web Browser**, it may not be possible to play media files in formats other than JPEG/PNG/GIF
- The **Web Browser** may be closed if there is insufficient memory space.
- On the **Web Browser**, only fonts embedded in the projector are used. Therefore, text may be displayed in different fonts than the ones on the PC.
- The **Web Browser** does not support file and font downloads.
- Since the **Web Browser** is a projector browser, it may function differently than PC browsers.
- Since the **Web Browser** is a projector browser, some of the content may not play properly.
- Caution is required for children accessing inappropriate content since this product can be connected to the Internet.
- Access to some of the apps, including the Web Browser, may be restricted in order to block inappropriate online content.
- Configure the settings in  (**Q. Settings**) →  → **Safety**.

Setting the Web Browser

Press  at the top of the screen and select the **Settings**.

- **On Startup**

You can set the startup page of the browser to **Open the New Tab page/Continue where I left off/Home page**.

- **Search Engines**

You can select the default search engine.

- **Private Browsing**

You can configure the settings not to leave records after searching.

- **Site Filtering**

- **Approved Sites** : You can configure the settings to open the previously registered web pages only.

- **Blocked Sites** : You can configure the settings to block specific websites.

* To use the **Site Filtering** function, you should enter the projector password.

Notifications

Using Notifications

The **Notifications** transfers real-time notifications from various apps and LG services. It shows the status of apps that are currently running and allows you to view, delete, and run all notifications in one place.

- 1 Press the  button on the remote control.
- 2 Launch the **Notifications** application.

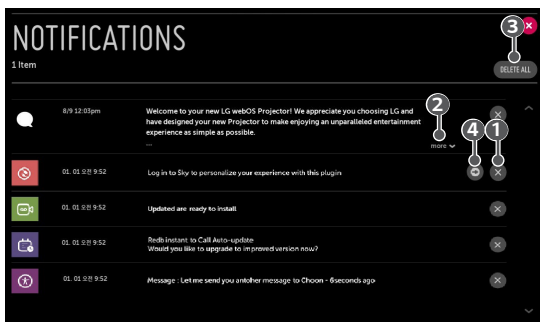

	Description
①	You can delete notifications.
②	For notifications with long content, press more to open them in full view.
③	You can delete all notifications.
④	You can launch the APP or move to URL.

TOUR LIST OF SETTINGS

Quick Settings

To use Setting function quickly

Press the  (Q. Settings) button on the remote control.

Displays a set of light-weight controls quickly and simply such as **Picture Mode**, **Aspect Ratio**, **Sound Out** and so on.

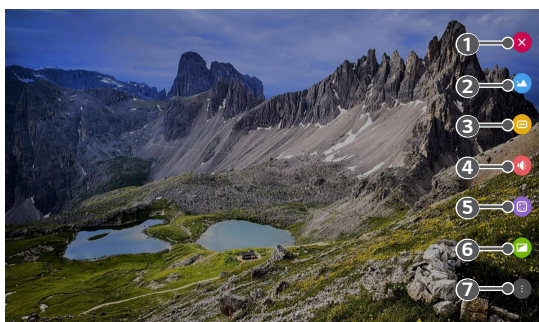

	Description
①	Closes the Quick settings.
②	You can set the Picture Mode .
③	You can set the Aspect Ratio .
④	You can choose the Sound Out .
⑤	You can set the PJT Mode .
⑥	You can set the Edge Adjustment .
⑦	You can set more options.

Picture Settings

Smart Picture Mode

 (Q. Settings) →  → **Picture** → **Smart Picture Mode**

When this is enabled, the projector will automatically adjust to the optimal picture settings based on data it receives on the genre of the program being played. Set the option to **On** to enable this mode.

- If you enable this feature, you cannot set **Picture Mode** manually.
- Only available with digital broadcasts.
- Channels connected to HDMI do not support **Smart Picture Mode**.
- This feature is available in certain countries only.

Picture Mode

 (Q. Settings) →  → **Picture** → **Picture Mode Settings** → **Picture Mode**

Select the picture mode that is best suited to your viewing environment, preferences or video type.

- **Vivid**
Sharpens the image by increasing the contrast, brightness, and sharpness.
- **Standard**
Displays the picture with normal contrast, brightness, and sharpness levels.
- **Cinema**
Optimizes the screen for movies.
- **Sports**
Optimizes the screen for sports games. Sharpens the image of rapid movements such as kicking or throwing a ball.
- **Game**
Optimizes the screen for gameplay.
- **Expert (Bright Room)/Expert (Dark Room)**
Allows an expert, or anyone who loves picture quality, to tune to the best picture quality.

Picture Mode Settings



 (Q. Settings) →  → **Picture** → **Picture Mode Settings**

This feature allows you to adjust the selected picture mode in detail.

- **Contrast**
Adjusts the contrast of the bright and dark areas of the picture. The closer to 100, the higher the contrast.
- **Brightness**
Adjusts the overall screen brightness. The closer to 100, the brighter the screen.
- **Sharpness**
Adjusts the sharpness of the image. The closer to 50, the sharper and clearer the image.
- **V Sharpness**
Adjusts the sharpness of the contrast edge in the vertical direction.
- **H Sharpness**
Adjusts the sharpness of the contrast edge in the horizontal direction.
- **Color**
Tones down or up the colors displayed on the screen. The closer to 100, the deeper the color.
- **Tint**
Adjusts the color balance between red and green displayed on the screen. The closer to Red 50, the more red the color will be. The closer to Green 50, the more green the color will be.
- **Color Temperature**
Adjusts the color temperature cool/medium/warm/natural.
 - The settings you specify only applies to the currently selected input mode.
To apply your current picture settings to all input modes, select **Apply to All Inputs**.
 - Depending upon the input signal or the selected picture mode, the available options may differ.
- **Apply to All Inputs**
Save the current customized setting values to currently selected picture moded for all inputs.
- **Reset**
This option will reset the picture settings.
 - You can reset the picture modes separately. Select the picture mode you wish to reset and enable it.

Advanced Controls/Expert Controls

Adjust screen settings for individual picture modes.

 (Q. Settings) →  → **Picture** → **Picture Mode Settings** → **Advanced Controls**

- **Dynamic Contrast**
Corrects the difference between the bright and dark areas of the screen for optimal results depending on the brightness of the picture.
- **Dynamic Color**
Adjusts the Color and saturation of the picture to make the image more colorful and lively.
- **Preferred Color**
Adjusts the colors of skin, grass and sky to your personal preferences.
- **Color Gamut**
Selects the range of Colors to display.
- **Super Resolution**
Adjusts the resolution to make dim and blurred images clearer.
- **Gamma**
Adjusts the medium brightness of the picture.

 (Q. Settings) →  → **Picture** → **Picture Mode Settings** → **Expert Controls**

If you set the picture mode to Expert, you can set the following functions.

- **Dynamic Contrast**
Corrects the difference between the bright and dark areas of the screen for optimal results depending on the brightness of the picture.
- **Super Resolution**
Adjusts the resolution to make dim and blurred images clearer.
- **Color Gamut**
Selects the range of Colors to display.
- **Edge Enhancer**
Shows clearer and distinctive yet natural edges of the video.
- **Color Filter**
Filters a specific Color spectrum in RGB Colors to fine-tune Color saturation and hue accurately.
- **White Balance**
Adjusts the overall color temperature of the screen as desired.
- **Color Management System**
This is a function used by experts when they adjust Colors using a test pattern of six Colors (**Red/Green/Blue/Cyan/Magenta/Yellow**) without affecting other Color areas. For normal images, adjustments may not result in noticeable Color changes.
 - Depending upon the input signal or the selected picture mode, the available options may differ.

Picture Options

 (Q. Settings) →  → **Picture** → **Picture Mode Settings** → **Picture Options**

Adjust detailed settings to further optimize the picture.

- **Noise Reduction**
Removes small dots that stand out so as to make the image clean.
- **MPEG Noise Reduction**
Reduces the noise produced during the creation of digital video signals.
- **Black Level**
Compensates the screen brightness and contrast by adjusting the darkness of the screen.
- **Real Cinema**
Provides a cinema-like experience.

Aspect Ratio

 (Q. Settings) →  → Picture → Aspect Ratio

- **16:9**

Displays an aspect ratio of 16:9.

- **Original**

Changes the aspect ratio to 4:3 or 16:9 depending upon the input video signal.

- **4:3**

Displays an aspect ratio of 4:3.

- **Vertical Zoom**

You can adjust the vertical dimension of the screen and align the screen vertically by using **Adjust Zoom Ratio** and **Adjust Screen Position**.

- **All-Direction Zoom**

You can adjust the horizontal/vertical/diagonal dimensions of the screen and align the screen horizontally/vertically by using **Adjust Zoom Ratio** and **Adjust Screen Position**.

- If you enable **Just Scan** on each screen size, you can view the screen in your selected size using the original image without any areas cropped.
- Viewing content from an external device or, for an extended period of time, having fixed text such as the program name or using an aspect ratio of 4:3 may result in image sticking.
- Depending upon the input signal, the available screen sizes may be different.

Edge Adjustment (4 Corner Keystone)

 (Q. Settings) →  → Picture → Edge Adjustment

Edge Adjustment (4 Corner Keystone) adjusts the horizontal and vertical sides of the projected image if the projector is at an angle and not perpendicular to the screen. This feature ensures the shape of the projected image is not distorted.

Use this feature only when the projector cannot be set up at the optimal angle.

Edge Adjustment may result in a loss of image quality.

- The value range of **Edge Adjustment** is as follows.
 - **Top Left** (H: 0 to 100, V: 0 to 100)
 - **Top Right** (H: -100 to 0, V: 0 to 100)
 - **Bottom Left** (H: 0 to 100, V: -100 to 0)
 - **Bottom Right** (H: -100 to 0, V: -100 to 0)
- When using **Auto Keystone**, the current value set for **Edge Adjustment** is changed to the value that has been set with **Auto Keystone**.

Energy Saving

 (Q. Settings) →  → Picture → Energy Saving

Reduces power consumption by adjusting peak screen brightness.

- **Minimum/Medium/Maximum**
Applies the pre-set **Energy Saving** mode.

Picture Test

 (Q. Settings) →  → Picture → Picture Test

First of all, start the Picture Test to see whether the video signal output is normal, and then select whether there is an error.

If there are no problems in the test picture, check the connected external device or broadcast signal.

Sound Settings

Sound Mode

 (Q. Settings) →  → **Sound** → **Sound Mode Settings** → **Sound Mode**

You can select the most suitable sound mode for each genre.

- **Standard**
Optimizes the sound for all types of content.
- **Cinema**
Optimizes the sound for cinemas.
- **Clear Voice III**
Boosts voice clarity.
- **Sports**
Optimizes the sound for sports.
- **Music**
Optimizes the sound for music.
- **Game**
Optimizes the sound for gameplay.

Sound Mode Settings

 (Q. Settings) →  → **Sound** → **Sound Mode Settings**

- **Balance**
You can adjust the volume of the left and right speakers.
- **Virtual Surround Plus**
Enjoy an immersive soundscape with the virtual multi-channel surround sound effect.
- **Equalizer**
You can set the desired sound by adjusting the equalizer directly.
(100 Hz/300 Hz/1 kHz/3 kHz/10 kHz)
- **Reset**
You can reset the sound effect settings.
 - You can only use **Virtual Surround Plus**, **Equalizer**, and **Reset** if **Sound Mode** is set to **Standard**.



Sound Out

Playing audio through the projector's internal speakers

 (Q. Settings) →  → **Sound** → **Sound Out** → **Internal Projector Speaker**

Audio is played through the projector's internal speakers.



Playing audio through an external audio device connected to the digital optical port or the HDMI(ARC) port

 (Q. Settings) →  → **Sound** → **Sound Out** → **Audio Out (Optical/HDMI ARC)**

Projector audio is played through an external audio device connected to the digital optical port or the **HDMI(ARC)** port. Enable SIMPLINK to play audio through **HDMI(ARC)**.

- If you select **Off** while SIMPLINK is enabled, the audio output setting is restored to the default setting in order to ensure uninterrupted audio output.

Configuring digital sound output settings

 (Q. Settings) →  → **Sound** → **Sound Out** → **Audio Out (Optical/HDMI ARC)** → **Digital Sound Out**

You can configure the **Digital Sound Out** settings.

- These settings are available only when an **Audio Out (Optical/HDMI ARC)/ Internal Projector Speaker + Audio Out (Optical)** is selected.

	Sound Input	Digital Sound Output
Auto	MPEG	PCM
	Dolby Digital	Dolby Digital
	Dolby Digital Plus	Dolby Digital
	HE-AAC	Dolby Digital
	DTS	DTS/PCM
	DTS Express	PCM
	DTS-HD MA	PCM/DTS
PCM	All	PCM

Connecting and Using an Audio Device Supporting LG Sound Sync (Optical)

 (Q. Settings) →  → Sound → Sound Out → LG Sound Sync (Optical)

You can connect an audio device that supports **LG Sound Sync (Optical)** to the optical digital audio output port to enjoy your projector's sound in richer quality and greater convenience.

- You can use the projector remote control to adjust the volume of the connected device.



Connecting and Using an Audio Device Wirelessly

 (Q. Settings) →  → Sound → Sound Out → LG Sound Sync / Bluetooth

You can connect wirelessly a Bluetooth audio device or a Bluetooth headset to enjoy your projector's sound in richer quality and greater convenience.

- If you have recently connected device that the sound bar supports **LG Sound Sync**, this feature automatically tries connecting to that device.
- In some devices, this feature automatically tries connecting to the recently connected device when the projector is turned on.
- We recommend that you connect an LG audio device that supports **LG Sound Sync**, using **LG TV** mode or **LG Sound Sync** mode on device.
- Press **DEVICE SELECTION** to view the connected devices or the devices that can be connected to connect any one of them.
- You can use the projector remote control to adjust the volume of the connected device.
- If the device fails to connect, check the power of the device to connect to and check if the audio device is working properly.
- Depending on the type of the Bluetooth device, the device may not connect correctly or an abnormal behavior may occur such as unsynchronized video and audio.
- Sound may stutter or sound quality may be reduced if:
 - the Bluetooth device is too far from the projector;
 - there are obstacles between the Bluetooth device and the projector; or
 - used together with radio equipment such as a microwave oven or wireless LAN.

Using Audio Out (Line Out)/Wired Headphones

 (Q. Settings) →  → **Sound** → **Sound Out** → **Audio Out (Line Out)/Wired Headphones**



Select **Wired Headphones** or **Audio Out (Line Out)** to optimise audio output according to the device connected.

- If you connect the wired headphones while the projector is powered on, it automatically detects the wired headphones and redirects audio through them.

Playing audio through the projector's internal speakers and external audio device simultaneously

Audio can be played through multiple devices simultaneously.

- Using **Internal Projector Speaker + Audio Out (Optical)**

 (Q. Settings) →  → **Sound** → **Sound Out** → **Internal Projector Speaker + Audio Out (Optical)**

Audio is played through the projector's built-in speakers and the audio device connected to the digital optical audio output port simultaneously.

- Using **Internal Projector Speaker + Wired Headphones**

 (Q. Settings) →  → **Sound** → **Sound Out** → **Internal Projector Speaker + Wired Headphones**

Audio is played through the projector's internal speakers and the **Wired Headphones** simultaneously.

Auto Volume

 (Q. Settings) →  → **Sound** → **Auto Volume**

Click **On** to adjust the volume automatically for different broadcasting companies so you can always listen to channels at the desired volume, even after switching the channels.

AV Sync Adjustment

 (Q. Settings) →  → **Sound** → **AV Sync Adjustment**

Adjusts the synchronization of the sound from the speaker that is working. The closer to the minus sign (-), the faster the audio output time. The closer to the plus sign (+), the longer the audio output speed compared to the default. (However, if **Sound Out** is set to **LG Sound Sync / Bluetooth**, the audio output speed can only be set faster. In this case, the closer to the plus sign (+), the faster the audio output speed compared to the default.)

If you select the **Bypass**, Outputs the broadcast signals or the sound from external devices without any audio delay. The audio may be output before the video because of the time the projector takes to process the video input.

Sound Test

 (Q. Settings) →  → **Sound** → **Sound Test**

Start the **Sound Test** to check that the sound signal output is normal, and then select whether there is an error.

If there are no problems in the test, check the connected external device or broadcast signal.

- Sound test is possible by Internal projector Speaker only.

Channels Settings

Auto Tuning

 (Q. Settings) →  → Channels → Channel Tuning → Auto Tuning

This function automatically searches and remembers channels that are available for viewing.

- If the antenna or cable is not connected properly, channels are not added.
- **Auto Tuning** finds and adds only channels being broadcast.
- A password box will appear in **Safety** mode.

Manual Tuning

 (Q. Settings) →  → Channels → Channel Tuning → Manual Tuning



You can manually tune and save channels.

You can check the signal strength of digital broadcasting.

Channel Manager

You can edit the selected channels from all the stored channels or add/delete them to/from the favorite channels.

Edit All Channels List

 (Q. Settings) →  → Channels → Channel Manager → Edit All Channels

You can lock or unlock the selected channels from all the stored channels, or you can set them to be skipped when switching channels.

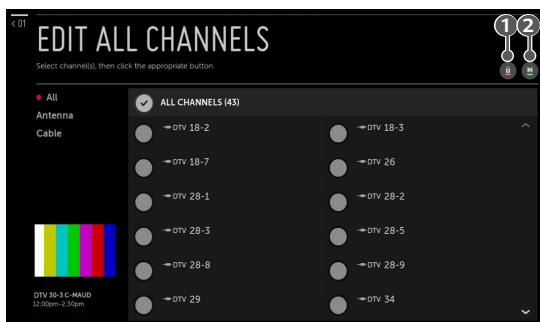

	Description
1	Lock the selected channels or unlock the locked channels.
2	Set the selected channels to be skipped when switching channels, or disable the skipping option of the channels previously set to be skipped.

- Available features may vary depending on the broadcast signal.

Edit Favorite Channels List

 (Q. Settings) →  → Channels → Channel Manager → Edit Favorites

You can add/delete desired channels to/from the favorite channels, change their positions, etc.

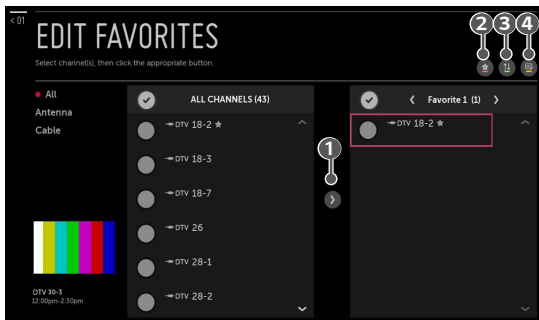

	Description
①	Select the desired channels from the all channels list and press the button to add them to the favorite channels list.
②	Delete the selected channels from the favorite channels list.
③	Select two channels from the favorite channels list, then press the button to swap their positions.
④	Change the name of the favorite channels list.

- If you have set up the Internet channels, you can also lock them, set them to be skipped, or add them to the favorite channels list. (This feature is available in certain countries only.)

Channel Advisor

 (Q. Settings) →  → Channels → Channel Advisor

If you set **Channel Advisor** to **On**, you can get channel or program recommendations from **Live TV** based on your viewing history.

Network

Projector Name

 (Q. Settings) →  → **Network** → **Projector Name**

You can use the screen keyboard to set the name for the smart projector to be used on the network.

- Up to 30 characters can be entered using the English alphabet.

Wired Connection (Ethernet)

 (Q. Settings) →  → **Network** → **Wired Connection (Ethernet)**

The projector will be connected automatically to the network if a cable connection is established.

To change network connection settings, select **Edit** in Network Settings.

Wi-Fi Connection

 (Q. Settings) →  → **Network** → **Wi-Fi Connection**

If you have set up the projector for a wireless network, you can check and connect to the available wireless Internet networks.

- **Add a Hidden Wireless Network**
If you input the name of network directly, you can add a wireless network.
- **Connect via WPS PBC**
Connects easily when the button of a wireless AP supporting PBC is pressed.
- **Connect via WPS PIN**
Connects easily when the PIN of the wireless AP that you wish to connect to is entered in to the AP configuration webpage.
- **Advanced Wi-Fi Settings**
If you input the information of network directly, you can enter a wireless network.

Wi-Fi Direct

 (Q. Settings) →  → **Network** → **Wi-Fi Direct**

Wi-Fi Direct is a function that allows your projector to connect with a Wi-Fi Direct-enabled device without a Wireless Router. You can open files stored on the devices that are connected via Wi-Fi Direct in the **Photo & Video** app and the **Music** app.

- 1 Enable Wi-Fi Direct on the device to which you want to connect.
- 2 A list of devices that can be connected to the projector is displayed.
- 3 Select a device to connect.
- 4 If the desired device accepts the request, Wi-Fi Direct will be connected.
- 5 From your desired connected device, select the video, music and photo files that you want to open on your projector via the LG TV Plus app or the content sharing feature.
- 6 You can open files stored on the devices that are connected via Wi-Fi Direct in the **Photo & Video** app and the **Music** app.

LG Connect Apps

 (Q. Settings) →  → **Network** → **LG Connect Apps**

LG Connect Apps Provides apps, like photo sharing or mobile-device remotes, with the ability to access and control certain features of your projector.

Set the **LG Connect Apps** option to **On**. (When you stop using it, please change it back to **Off**.)

- If you want to disconnect all devices from your projector, click the **REVOKE PAIRING** on your screen.

General

Language

 (Q. Settings) →  → **General** → **Language**

You can choose the menu language displayed on the screen and the audio language of the digital broadcast.

- **Menu Language**

You can select one of the menu languages to be displayed on the screen.

- **Audio Language**

You can choose the language you want when watching a digital broadcasting program, which includes multiple audio languages.

For programs that do not support multiple languages, the default will be used.

- Applies to digital broadcasting.

- **Keyboard Languages**

Select the language to use the on-screen keyboard.

Location

 (Q. Settings) →  → **General** → **Location**

You can change the location setting of your smart projector.

- **Service Area Zip Code**

This function is used to set the broadcast location of the projector by entering your zip code.

- **LG Services Country**

If you don't set the **Set Automatically**, you can select the country manually.

- You must set the country manually when you are not connected to the network.
- The configurable items differ depending upon the country.

Time & Date

 (Q. Settings) →  → **General** → **Time & Date**

You can check or change the time while watching the projector.

- **Set Automatically**

Automatically sets the time displayed on the projector screen to the time of the digital broadcast sent by the broadcasting company.

- **Time/Date/Time Zone**

You can set the time and date manually if the automatically set current time is incorrect.

Sleep Timer

 (Q. Settings) →  → **General** → **Timers** → **Sleep Timer**

Sets the projector to turn off at a specified time.

If you want to disable **Sleep Timer**, select **Off**.

Timer Power On/Timer Power Off

 (Q. Settings) →  → **General** → **Timers** → **Timer Power On/Timer Power Off**

You can set the power on/off time for the projector.

Select **Off** if you are not going to set **Timer Power On/Timer Power Off**.

To use **Timer Power On/Timer Power Off**, set the time correctly.

- The projector will be turned off automatically if you do not press any buttons for 120 minutes even after the projector is turned on at the time set by **Timer Power On**. To ensure the projector does not automatically turn off, set **2 Hours Auto Power Off** to **Off**. (This feature is only available in certain countries.)

Auto Off

 (Q. Settings) →  → **General** → **Timers** → **Auto Off**

If there is no input signal or button press, the projector automatically turns off after the preset time has elapsed.

Account Management

 (Q. Settings) →  → **General** → **Account Management**

Manage your account information and settings.

Power Saving Mode

 (Q. Settings) →  → **General** → **Power Saving Mode**

Set power options to reduce energy consumption.

- **Auto Power Off**

Set the projector to turn off automatically when there has been no user input for a specified amount of time.

- **HDD Power Saving Mode**

If you set the mode to **On**, the USB HDD connected to the projector will go into power-saving mode when it has been left unattended for an extended period of time.

Advertising Cookies

 (Q. Settings) →  → **General** → **Advertising Cookies**

If your projector is connected to the Internet, webOS may use a frequency capping cookie to keep track of the number of times an ad is shown on your projector.

This information is used to help limit the number of times the same ad is displayed. You can clear this cookie or turn it on or off at any time by going to the **Advertising Cookies** setting on your projector.

No personally identifiable information is tied to this cookie.

- This feature is available in certain countries only.

Mobile Projector On

 (Q. Settings) →  → **General** → **Mobile Projector On**

If this option is set to **On**, you can turn on your projector using an application that supports **Mobile Projector On** and see the screen of the application on your projector.

- The projector should be connected to a network.
- The projector must be plugged in.
- The projector and the device to be used should be connected to the same network.
- To connect for the first time, make sure the device to be used is ready to connect.
- This feature is only available in certain countries.

SIMPLINK (HDMI-CEC)

 (Q. Settings) →  → **General** → **SIMPLINK (HDMI-CEC)**



You can conveniently control and use various multimedia devices connected through HDMI with the projector remote control.

PJT Mode

 (Q. Settings) →  → **General** → **PJT Mode**

This function turns the projected image upside down or flips horizontal.

Auto Keystone

 (Q. Settings) →  → **General** → **Auto Keystone**

Auto Keystone provides a rectangular screen image by automatically adjusting the keystone number when there is a trapezoidal screen image caused by tilting of the projector.

When using **Auto Keystone**, the current value set for **Edge Adjustment** is changed to the value that has been set with **Auto Keystone**.

- **On**
Automatically adjusts the keystone number.
- **Off**
Manually adjusts the keystone number.

Auto Power

 (Q. Settings) →  → **General** → **Auto Power**

Makes the projector turn on automatically when the power code is connected to the projector.

- **On**
When the power code is connected to the projector, it turns on automatically.
- **Off**
When the power code is connected to the projector, it goes into standby mode.

High Altitude

 (Q. Settings) →  → **General** → **High Altitude**

If the projector is used at an altitude higher than 1500 meters, turn this on. Otherwise, the projector may overheat or its protection function may be activated. If this happens, turn the projector off and then on again after waiting for several minutes.

- This feature is available on certain models only.

LG Wireless Keyboard

 (Q. Settings) →  → **General** → **LG Wireless Keyboard**

This feature enables you to connect a LG wireless keyboard to your device. Turn on the device, set it to pairing mode, and then click **CONNECT** on your projector screen.

- Supported keyboard
 - LG Rolly Keyboard
- If there is a LG wireless keyboard previously connected, it will be automatically reconnected to your projector once your projector turns on.
- To disconnect the existing connection, click **DISCONNECT**.
- This feature is available on certain models only.

Settings Help

 (Q. Settings) →  → **General** → **Settings Help**

If you select the setting menus, you will see the hints of the settings. Turn on/off description box in settings.

Screen Saver

 (Q. Settings) →  → **General** → **Screen Saver**

When the currently displayed app has not received any user input for an hour, it will be replaced by a **Screen Saver**.

- If you turn this option **Off**, the current picture may create an afterimage burned into your screen, possibly permanently.

Reset to Initial Settings

 (Q. Settings) →  → **General** → **Reset to Initial Settings**

Return projector to its initial settings. This will revert all settings to their default values.

After reset, the projector will automatically turn off and on.



- If **Safety** is set to **On**, you should type the password to **Reset to Initial Settings**.
- Do not turn off the power during initialization.

About This Projector

 (Q. Settings) →  → **General** → **About This Projector**

You can check the information about Customer Services. (Software Update, projector Information, User Agreements, and so on.)

Self Diagnosis

 (Q. Settings) →  → **General** → **Self Diagnosis**

Troubleshoots functional problems that can arise while using the product.

Home/Store Mode

 (Q. Settings) →  → **General** → **Home/Store Mode**

You can choose between **HOME MODE** and **STORE MODE**.

To use the projector at home, select **HOME MODE**.

STORE MODE only when the projector will be displayed in store. Select the Store mode for settings optimized for store display.

Safety Settings

- Set **Safety** to **On**.
- The initial password is set as "0000".
- It may differ by model.

TV Lock

 (Q. Settings) →  → **Safety** → **TV Program Locks** → **TV Lock**

Locks the TV shows you do not want your children to watch. In addition, locks the TV shows of your choice based on ratings by using the parental control function (V-Chip).

- **Children Age: TV-Y** (Preschool children aged 2-6 years), **TV-Y7** (Advise school children aged over 6.)
- **Fantasy Violence: TV-Y7** (Advise school children; Suitable for children aged over 7 years. May contain fantasy violence.)
- **General Age: TV-G** (General Audience. All ages admitted.) **TV-PG** (Parental Guidance Suggested. Some material may not be suitable for preschool children.) **TV-14** (Parents Strongly Cautioned. Some material may not be suitable for children under 14.) **TV-MA** (Adults Only. Not suitable for children under 17.)
- **Sexually Suggestive Dialogue:** (Recommended Language) **TV-PG** or **TV-14**
- **Adult Language:** (Violent Language) **TV-PG, TV-14** or **TV-MA**
- **Sexual Situations:** (Sexually Explicit) **TV-PG, TV-14** or **TV-MA**
- **Violence: TV-PG, TV-14** or **TV-MA**

Movie Lock

 (Q. Settings) →  → **Safety** → **TV Program Locks** → **Movie Lock**

Blocks films that are broadcast and contain inappropriate content, based on the Motion Picture Association of America (MPAA) rating.

- **G** (General Audiences): All ages admitted.
- **PG** (Parental Guidance Suggested): Some material may not be suitable for children.
- **PG-13** (Parents Strongly Cautioned): Some material may be inappropriate for children under 13.
- **R** (Restricted): Under 17 requires accompanying parent or adult guardian.
- **NC-17**: No one 17 and under admitted.
- **X**: Adults only.

Downloadable Rating

 (Q. Settings) →  → **Safety** → **TV Program Locks** → **Downloadable Rating**

This function is only enabled when the TV receives the Region5 rated data. The name of the rating option may differ.

- This feature is available in certain countries only.

TV Rating English

Select Canadian English Rating System.

- **None**: View all programs
- **E**: Exempt
- **C**: Children
- **C8+**: Children aged 8 or older
- **G**: Suitable for viewing by all ages
- **PG**: Parental guidance advised
- **14+**: 14 or older
- **18+**: Adult program

TV Rating French

Select Canadian French Rating System.

- **None:** View all programs
- **E:** Exempt
- **G:** General
- **8+:** Not suitable for general audience and children
- **13+:** Suitable for 13 years and over
- **16+:** Suitable for 16 years and over
- **18+:** Adults only

Channel Locks

 (Q. Settings) →  → **Safety** → **Channel Locks** → Select the Channels to lock. →  → **LOCK**

You can lock the channels you do not want your children to watch. There will be no images or sound when locked channels are selected. To watch locked channels, enter the password.



Application Locks

 (Q. Settings) →  → **Safety** → **Application Locks** → Select the Applications to lock.

You can lock or unlock the application.

- The lock function is not immediately available for the currently running application.

Input Locks

 (Q. Settings) →  → **Safety** → **Input Locks** → Select the Inputs to lock. You can lock or unlock the Input Locks.

Reset PIN Code

 (Q. Settings) →  → **Safety** → **Reset PIN Code**
Set or change the password for the projector.

Accessibility

Pointer Options

 (Q. Settings) →  → **Accessibility** → **Pointer Options**

You can set the pointer speed and shape you want while it is on the screen.

To see the details, click the **MAGIC REMOTE CONTROL** in 'Owner's Manual'.

Menu Transparency

 (Q. Settings) →  → **Accessibility** → **Menu Transparency**

You can set interface screen transparency for some of the features displayed on your projector screen.

If you set this option to **Off**, interface screens are displayed non-transparently.

Closed Caption

 (Q. Settings) →  → **Accessibility** → **Closed Caption**

View subtitles when the TV station provides subtitled programming. Program subtitles work only on digital/analog broadcasts or external input.

Change **Closed Caption** to **On** and select caption setting.

- **Analog Mode**

CC 1 - CC 4 (Closed Captioning)/**TEXT 1-TEXT 4**

Displays the audio portion of a TV program as text on the projector screen. CC1 is the most common mode in use.

Field 1 data channels: two Captions (CC1, CC2), two Text (T1, T2).

Field 2 data channels: two Captions (CC3, CC4), two Text (T3, T4).

- **Digital Mode**

Service 1 - Service 6

- This is only available for the digital broadcasting system.

Digital Mode Options → **Style**

- Set up the size and color of the subtitles on **Digital Mode Options**. Please select **Set By Program** or **Custom**.

- Select **Custom** to adjust minute options such as the subtitles' size and color.

Audio Guidance

 (Q. Settings) →  → Accessibility → Audio Guidance

If **Audio Guidance** is set to **On**, audio guides will be provided in various situations, such as when you change channels, adjust the volume or change settings and input signals.

- **Speed**
Adjust the speed of spoken guide.
- **Volume**
Adjust the volume of spoken guide.
- **Pitch**
Adjust the tone of spoken guide.
 - This feature is available on certain languages only.
 - This feature is available in certain countries only.
 - The configurable items differ depending upon country.
 - For visually impaired users.

Projector Power Sound



 (Q. Settings) →  → Accessibility → Projector Power Sound

This feature lets you turn on/off the sound effects that you hear when your projector is switched on or off.

- This feature is available in certain countries only.



TROUBLESHOOTING

If you experience any of the problems below while using the product, please check the following. There may be no problem with the product.

Information on customer service for product problems is available in  (Q. Settings) →  → **General** → **About This Projector** on the projector.

Abnormal Operation

I cannot see some channels.

- Adjust the position or direction of the antenna.
- Save the desired channels in  (Q. Settings) →  → **Channels** → **Channel Tuning** or **Channel Manager**.

The screen does not appear for some time after power-on.

- This is because there is a noise-removal process to eliminate any possible noise that may appear during power-on. This does not mean the product is defective.

The pointer of Magic Remote is not appear in the screen.



- Your Magic Remote may have run out of batteries.
Replace the batteries and register your Magic Remote again following the instructions shown in MAGIC REMOTE CONTROL of Owner's Manual.

The projector makes too much noise.

[Depending upon model]

- Due to the built-in pressure sensor, the fan runs in high altitude mode at altitudes higher than 1500 m above sea level.
- When the fan runs in high altitude mode, the fan's RPM may increase and the noise may rise.

Screen Problems

First of all, perform a  (Q. Settings) →  → **Picture** → **Picture Test** for check any abnormalities in the projector.



The screen overlaps or there are stripe patterns on all channels or on a specific channel.

- Turn the antenna toward the broadcasting station or connect the antenna correctly in accordance with the How to Connect an Antenna section.

The screen shakes after the momentary appearance of vertical/horizontal lines and net pattern.

- Stop using items such as wireless telephones, hairdryers, electrical drills etc. The problem is caused by high-frequency electronic devices such as another projector or strong electromagnetic sources.

A digitally broadcast program stops or its screen is broken.

- This happens when a signal is weak or reception is unstable. Adjust the antenna direction or check the cable connection.
- If the signal strength is too low in  (Q. Settings) →  → **Channels** → **Channel Tuning** → **Manual Tuning**, contact the broadcasting station or management office to have the signals checked.

I cannot see digital broadcasts even though I am using a cable television.

- Check your subscription information with your cable television service provider or ask for the signal to be checked. (Some products do not provide digital broadcasts.)

The screen is blank or the image is blurred when an HDMI cable is used.

- Check that the HDMI® cable meets the required standards. If it is not a certified HDMI® cable, the screen may flicker or may not display anything.
- Check that the cable is properly connected. Improper connection may cause screen flicker.



It does not work when I connect a USB device.

- Check that the USB and USB cable versions are 2.0 or higher.





Sound Problems

First of all, perform a  (Q. Settings) →  → **Sound** → **Sound Test** to check for any abnormalities in the projector.

The screen is fine, but it does not play any sound.

- Try another channel.
-  (Q. Settings) →  → **Sound** → **Sound Out**
Check whether the **Sound Out** is set to **Internal Projector Speaker + Audio Out (Optical)** or **Internal Projector Speaker**.



The stereo sound is not clear on an analog channel, or there is no sound from one of the speakers.

- Applies only in countries where sound multiplex broadcasting is available.
 **Wheel (OK)** → 
Select **MONO** in Multi Audio if you are out of range or sound multiplex broadcasting is not stable.
-  (Q. Settings) →  → **Sound** → **Sound Mode Settings** → **Balance**
Adjust the balance as necessary with the Navigation button in **Balance**.

The TV sound is not synchronized with the picture, or the sound sometimes breaks up.

- If this happens on only some of the channels, it may be caused by the broadcasting company's transmission signal. Please have your broadcasting services provider (wired/cable) diagnose the problem.

The volume changes when I change the channel.

- The volume of different broadcasting stations transmission output may vary.
-  (Q. Settings) →  → **Sound** → **Auto Volume**
Set **Auto Volume** to **On**.

The sound does not work or only the background music is played in some programs. (Programs produced for export by broadcasting companies)

-  **Wheel (OK)** → 
- Set your language preference in **Audio Language**.

The sound does not play when I connect to the HDMI/USB port.

- Check that you are using a high-speed HDMI® cable.
- Check that the USB and USB cable versions are 2.0 or higher.
- Use a normal music file (*.mp3, *.wav, *.ogg, *.wma).

PC Connection Problems

The screen remains blank after it is connected to a PC.

- Check that the PC is properly connected to the projector.
- Turn the projector off and back on using the remote control.
- Restart the PC with the projector on.
- Check that the current screen resolution supports the PC input.
- To use dual monitors, check that the PC or notebook supports dual-monitor mode.
- Reconnect the high speed HDMI cable.

The sound does not play when the PC is connected with an HDMI cable.

- Contact your video card manufacturer to check the HDMI audio output. (Video cards designed for use with DVI format files need to be connected separately with an audio cable.)

The screen is cut off or moved to one side after it is connected to a PC.

- Set to a resolution that supports the PC input. (Reboot your PC after changing the resolution.)

Photo & Video Movie Playback Problems

I cannot find a file in the **Photo & Video**.

- Check that the files on the USB storage device can be read by a PC.
- Check that the file extension is supported.



I get a message saying "This file is not supported" or the sound is playing normally but the video is not.

- Check that the file plays without any problems on a PC's video player. Also check for file damage.
- Check that the file extension is supported.
- Check that the resolution is supported.
- Check that the video codec is supported.
- Check that the frame rate is supported.

I get a message saying “This audio is not supported” or the video is playing normally but the audio is not.

- Check that the file plays without any problems on a PC’s video player. Also check for file damage.
- Check that the file extension is supported.
- Check that the audio codec is supported.
- Check that the bit rate is supported.
- Check that the sample rate is supported.
- Check that the audio channel separation is supported.

I cannot see the subtitles.

- Check that the file plays without any problems on a PC’s video player. Also check for file damage.
- Check that the video and subtitle files have the same name.
- Also check that both the video file and the subtitle file are in the same folder.
- Check that the subtitle file format is supported.
- Check that the language is supported. (You can check the language of the subtitle file by opening the file in the Notepad.)
- If subtitles encoding is incorrectly set, subtitles may not be displayed properly. Select  →  in the control panel at the bottom of the video playback screen and change the **CODE PAGE** value.
- If you play a video file stored on another device by using the content sharing feature, subtitles may not be available depending on the program you use.

Network Connection Problems

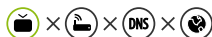

When X appears next to projector

- Check the projector or the AP (Router).
- Check the connection status of the projector, AP (Router) and Cable Modem.
- Power off and power on in the following order;
 1. The Cable Modem, wait for the Cable Modem to reset.
 2. The AP (Router), wait for the AP (Router) to reset.
 3. The projector.
- If you are using a wireless connection, change the SSID (Network name) and wireless channel of AP (Router).
- If you are using a static IP, enter the IP directly.
- Contact internet service provider or AP (Router) companies.



When X appears next to Gateway

- Check the AP (Router) or consult your Internet service provider.
- Unplug the power cord of the AP (Router), Cable Modem, wait 10 seconds. Reapply power.
- Initialize (Reset) on the AP (Router) or Cable Modem.
- Contact internet service provider or AP (Router) companies.
- Check the AP (Router) manufacturer's website to make sure your router has the latest firmware version installed.



When X appears next to DNS

- Check the AP (Router) or consult your Internet service provider.
- Unplug the power cord of the Cable Modem or the AP (Router), wait 10 seconds. Reapply power.
- After the Cable Modem or AP (Router) has Initialized (Reset), try to reconnect.
- Check that the MAC address of the projector/AP (Router) is registered with your Internet service provider. (The MAC address displayed on the pane of the network status window should be registered with your Internet service provider.)

LG Account Problems

In some countries, access to the website (www.lgappstv.com) may be restricted.

I have already signed up on the projector. Do I still have to sign up again at the website (www.lgappstv.com)?

- If you have already signed up on your projector, you do not have to sign up again on the website. You can sign into the website by using the same ID and password and entering the additional information to complete the email verification process.

Is it possible for the family members to use different IDs on the same projector?



- You can register multiple IDs per projector.

I forgot my ID/Password. What should I do?

- You can initialize the password through E-mail when you select FORGOT PASSWORD? on the sign in screen.
- If you signed up on a PC, you can find your ID/Password on the website (www.lgappstv.com).

Contents Problems

I cannot see any content in HOME.

- This feature is available in certain countries only.
You may not be able to see the content if the service country setting has been changed. Change to the service country you are going to use the service from in  (Q. Settings) →  → **General** → **Location** → **LG Services Country**.

Internet Browser Problems

Some parts of a particular website are not visible when I am using the Internet.

- The **Web Browser** supports only HTML5 media and not Flash Plug-in.
- The **Web Browser** does not support plug-in installation.
- On the **Web Browser**, it may not be possible to play media files in formats other than JPEG/PNG/GIF

The Internet browser automatically shuts down when I visit a website.

- The Internet browser may be forced to shut down if the available memory size is not sufficient to accommodate the image information for a website.

