

4a. Controlling the ZVOX Soundbar

Using Your Preferred Remote Control:

Your preferred TV remote control can control Volume, Mute and Power on the ZVOX soundbar. See the separate instruction sheet that describes the process of teaching the ZVOX to respond to these commands. The ZVOX soundbar remote will always provide a full range of adjustments, along with your preferred remote.

Button functions on the soundbar remote control

Volume

The VOLUME buttons operate in the normal manner

Power (STANDBY)

The Power button toggles the soundbar between STANDBY and On. **Note:** A soundbar automatically enters STANDBY if it is silent for longer than approximately 30 minutes. A soundbar will turn back on when it senses a restored digital signal (Input 1 only) or an infrared power or volume adjustment.

Input Selection:

A brief press and release of the INPUT button on the soundbar remote control allows you to select between the four separate inputs on the soundbar.

Input 1 – digital

Input 2 – digital

Input 2 – analog (RCA jacks)

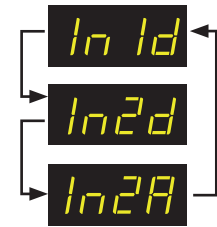
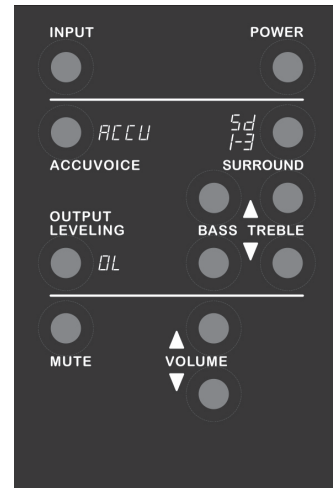

Mute

The MUTE button on the soundbar remote control operates in the normal manner. When MUTE is active, the display will show a blinking -00- for 20 seconds.



Bass and Treble

The Bass control has a range of -6 to 4. The Treble control has a range of -4 to 4.

Note: The bass output of a soundbar system is affected by its position within a room. You may find it sounds best with slightly more or less bass than the neutral setting.

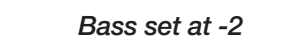

Surround Settings

There are three SURROUND levels:

- Surround One (“Sd 1”) has low virtual surround effect and strong vocals. Use this setting if vocal clarity is important to you.
- Surround Two (“Sd 2”) has moderate virtual surround effect and moderate vocals. Most people prefer this setting for most program material.
- Surround Three (“Sd 3”) has strong virtual surround effect and moderate vocals. Many people prefer this setting when watching movies.



Output Leveling

Press this button to prevent large changes in volume. When engaged, it boosts quiet dialog and lowers the output of loud commercial breaks. It also reduces volume swings between cable or satellite channels. This feature can be used along with any of the three Surround settings.



Accuvoice

Press this button to increase the clarity of most voices. Pressing Accuvoice overrides the current Surround setting. A second press returns the soundbar to the last-used Surround setting.



4b. End Panel Controls on the Soundbar

On the viewer’s right end of the soundbar are four buttons.

A) POWER button:

This button turns the soundbar “ON” if it is in Standby. If this button pressed briefly while the soundbar is “ON”, it will mute and unmute the soundbar. To turn off the soundbar, press and hold down this button for about five seconds.

B) Volume Up/Down rocker button

Adjusts volume up and down. Pressing either side of this button will “unmute” the speaker if it is muted.

C) Input button:

A brief press and release of the INPUT button selects the next input in sequence.

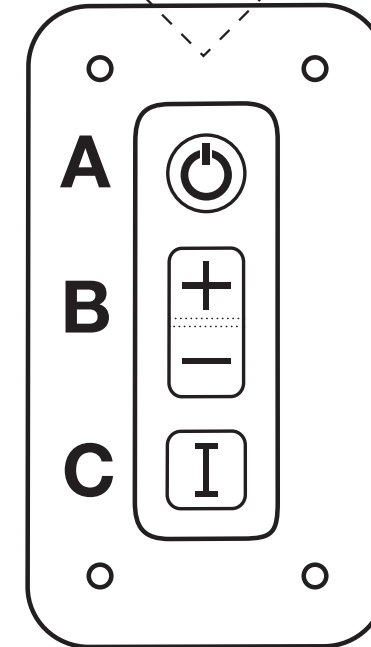
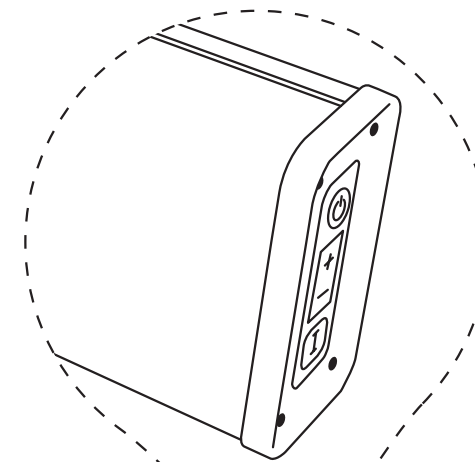

5. Tonal Profile Setting

The soundbar has three settings to better match the acoustics of its room position.

Face Front PS16 - on a flat surface, facing front.

Face Up..... PS17 - on a flat surface, facing up.

Wall mount PS18 - on a vertical surface, facing into the room.

The default setting for the soundbar is **Face Front**.

If your soundbar’s position is **Face Up** or **Wall mount**, you should select PS17 or PS18 from the PS menu.

PS Menu: you bring up the PS menu by pressing down on two buttons on the end panel of the soundbar: Power (⏻) and Volume Up (+). After about five to seven seconds you should see PS start flashing. The first time you bring up the PS menu, it should show “PS 0”.

Once you see the PS display, release the buttons. Then press and release the Volume Up button to increase the PS number. Continue pressing and releasing the Volume Up button until you reach the setting you want: PS16, PS17 or PS18.

For further information about the options provided by the PS menu, see the separate information sheet **Soundbar Adjustment Options**, available online at **ZVOX Audio's website**.

STILL NEED ASSISTANCE? If your home TV system does not conform to the descriptions in this guide, don’t hesitate to send an inquiry to info@zvoxaudio.com or call ZVOX Audio at (866) 367-9869. Please provide your TV brand and model number. A ZVOX Audio representative should be available (Eastern Time Zone) 9:30 AM to 7:30 PM Monday through Friday.

6. Soundbar Wall Mounting Information

Dimensioned diagrams of each ZVOX Audio soundbar model can be found on **ZVOX Audio's website**.

The soundbar has two keyhole mounting sites on its back panel. You can mount the soundbar onto two screwheads using these mounting sites. A ZVOX Audio soundbar weighs between 15 and 20 pounds. **NOTE:** It is the installer’s responsibility to ensure the screws are installed into the wall or other surface securely and that the screwheads are the correct size for the hanger mounts on the rear of the soundbar. **ZVOX Audio recommends your mounting sites be able to support at least twice the weight of the soundbar.**

ZVOX Audio SB380 Soundbar

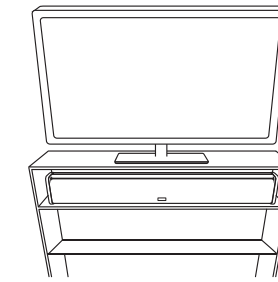

Face Front

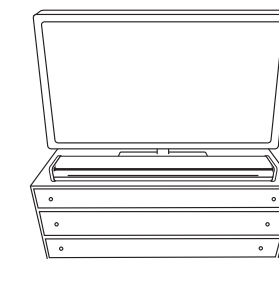

Face Up

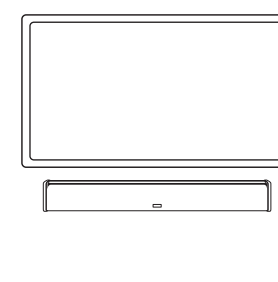

Wall Mount

Setup & Operation

Don’t Worry **It’s Pretty Easy.**

STEP 1

Position The System.

STEP 2

Connect One Signal Cable.

STEP 3

Connect the Power cable.

STEP 4

Use the Soundbar remote to turn on power and adjust volume.

**Home Theater
Made Simple!**

What’s In The Box

Soundbar • Remote control • Instruction sheets
AC power cord with integral power supply • Optical Digital and Analog signal cables



(866) 367-9869 | info@zvoxaudio.com

READ THIS FIRST

Important Safety Instructions For ZVOX Audio System

WARNING

TO PREVENT FIRE OR SHOCK HAZARD, DO NOT EXPOSE THIS APPLIANCE TO RAIN OR MOISTURE.

THIS APPLIANCE SHALL NOT BE EXPOSED TO DRIPPING OR SPLASHING WATER AND NO OBJECT FILLED WITH LIQUIDS SUCH AS VASES SHALL BE PLACED ON APPARATUS.

CAUTION

RISK OF ELECTRICAL SHOCK, DO NOT OPEN

Warning: To reduce the risk of electrical shock, do not remove cover (or back) – no serviceable parts inside. Refer servicing to qualified service personnel.

The exclamation point within an equilateral triangle is intended to alert the user to the presence of important operating and maintenance (servicing) instructions in the literature accompanying the appliance.

This lightning flash with arrowhead symbol, within an equilateral triangle, is intended to alert the user to the presence of uninsulated "dangerous voltage" within the product's enclosure that may be of sufficient magnitude to constitute a risk of electrical shock to persons.

Important Safety Instructions

- Read these instructions.
- Keep these instructions.
- Heed all warnings.
- Follow all instructions.
- Do not use this apparatus near water.
- Clean only with dry cloth.
- Do not block any ventilation openings. Install in accordance with the manufacturer's instructions.
- Do not install near any heat sources such as radiators, heat registers, stoves, or other apparatus (including amplifiers) that produce heat.
- Do not defeat the safety purpose of the polarized or grounding-type plug. A polarized plug has two blades with one wider than the other. A grounding type plug has two blades and a third grounding prong. The wide blade or the third prong are provided for your safety. If the provided plug does not fit into your outlet, consult an electrician for replacement of the obsolete outlet.
- Protect the power cord from being walked on or pinched particularly at plugs, convenience receptacles, and the point where they exit from the apparatus.
- Only use attachments/accessories specified by the manufacturer.
- Use only with the cart, stand, tripod, bracket, or table specified by the manufacturer, or sold with the apparatus. When a cart is used, use caution when moving the cart/apparatus combination to avoid injury from tip-over.
- Unplug this apparatus during lightning storms or when unused for long periods of time.
- Refer all servicing to qualified service personnel. Servicing is required when the apparatus has been damaged in any way, such as power-supply cord or plug is damaged, liquid has been spilled or objects have fallen into the apparatus, the apparatus has been exposed to rain or moisture, does not operate normally, or has been dropped.
- Grounding or Polarization**—This product may be equipped with a polarized alternating-current line plug (a plug having one blade wider than the other). This plug will fit into the power outlet only one way. This is a safety feature. If you are unable to insert the plug fully into the outlet, try reversing the plug. If the plug should still fail to fit, contact your electrician to replace your obsolete outlet. Do not defeat the safety purpose of the polarized plug.
- Alternate Warnings**—This product is equipped with a three-wire grounding-type plug, a plug having a third (grounding) pin. This plug will only fit into a grounding-type power outlet. This is a safety feature. If you are unable to insert the plug into the outlet, contact your electrician to replace your obsolete outlet. Do not defeat the safety purpose of the grounding-type plug.
- Ventilation**—Slots and openings in the cabinet are provided for ventilation and to ensure reliable operation of the product and to protect it from overheating, and these openings must not be blocked or covered. The openings should never be blocked by placing the product on a bed, sofa, rug, or other similar surface. This product should not be placed in a built-in installation such as a bookcase or rack unless proper ventilation is provided or the manufacturer's instructions have been adhered to.
- The MAINS plug or an appliance coupler is used as the disconnect device, the disconnect device shall remain readily operable.
- CLASS II apparatus with double insulation, and no protective earth provided.
- CAUTION:** Danger of explosion if the remote control battery is incorrectly replaced. Replace only with the same or equivalent type.
- WARNING:** The remote control battery (battery or batteries or battery pack) shall not be exposed to excessive heat such as sunshine, fire or the like.
- No naked flame sources, such as lighted candles, should be placed on the apparatus.

Special Safety Warnings Regarding Placement of the ZVOX System and Other Equipment

Stable Placement. Do not place the ZVOX system on an unstable cart, stand, bracket or table. The ZVOX system may fall, causing serious injury to a child or adult and serious damage to the product. Do not use the ZVOX system on any unstable surface.

The soundbar has two keyhole-shaped mounting locations on the back panel. These mounting sites will securely hold a screwhead that is no larger

than 3/8" (10mm) in diameter. It is the installer's responsibility to confirm each mounting site used to support the the soundbar has an adequate weight-handling margin to support both the weight of the soundbar and extra weight that may inadvertently be applied as a result of a house-hold accident. Damage that may occur to the soundbar during or after the mounting process or any other installation activity is NOT covered under the terms of the ZVOX Audio limited warranty.

Simple Setup – Just Four Steps

1

Place or hang the Soundbar.

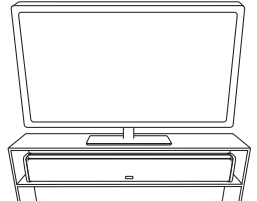

Face Front

2

Connect the Soundbar to your TV.

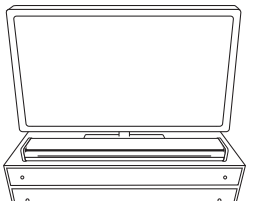

Face Up

3

Learn the features of the Soundbar.

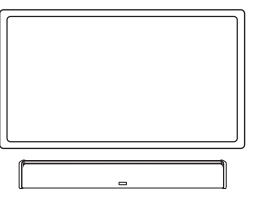

Wall Mount

4

"Teach" the Soundbar your preferred remote.

1. Speaker placement

You can place the soundbar on any flat, stable surface near your TV. There are three general placement options, illustrated above:

- Face Front** You can place the soundbar on a flat surface so it faces forward. This placement is ideal for a shelf below, above or near the television.
- Face Up** You can place the soundbar facing up—often in front of the television. The bottom of the soundbar should face the listening area. Check to ensure the soundbar does not block the television infrared remote sensor. There should be no shelf or flat surface immediately above the soundbar in this configuration.
- Wall Mount** The soundbar has two sturdy keyhole-shaped hanger mounts on the back panel. You can hang the soundbar on two screwheads that are securely installed in a wall or other vertical surface.

- Consider the *finish* of the surface that will support the soundbar. **It is the soundbar owner's responsibility to insure that a surface finish that contacts the soundbar is protected, should this be a concern of the soundbar owner.** The contact area on the soundbar is made of inert synthetic materials that typically do not react with furniture or wall finishes. But any wall or surface finish can be altered by having any heavy object resting on it for a long period of time. **Place an appropriate barrier between any surface and the soundbar if you are concerned about the finish of the supporting surface.**

- A safe, secure installation is the soundbar owner's responsibility.
- Use an unswitched AC outlet to provide power to a soundbar. With the soundbar's Auto Standby feature turned on, an soundbar will enter its Standby state on or before 30 minutes of inactivity. A soundbar uses less than 0.5 watt in Standby. Using a switched AC outlet to cut off AC power to a soundbar system is not recommended. It delays subsequent turn-on.

- Do not place any objects on top of a soundbar.

2. Connecting your TV to the SB380 Soundbar

All current TVs have an audio output. It is likely that one of the cables provided with the soundbar can be used to connect the TV audio output to an input on the soundbar. **DO NOT** disconnect any video program source connected to your TV (like a cable or satellite set top box, DVD/Bluray or similar).

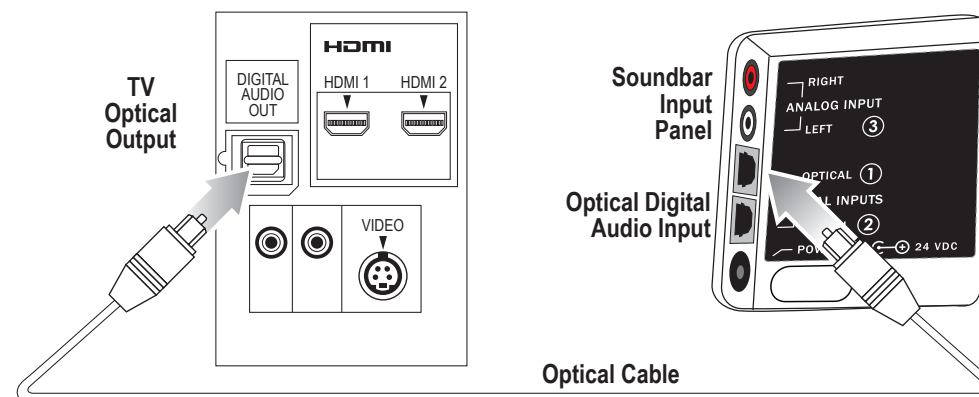

Optical Digital Audio Output Jack (see above image)

Most HDTVs have an optical digital audio output jack. Use the provided optical cable to connect the TV's output jack to optical input 1 on the soundbar.

Analog Audio Output

You can connect a TV set's analog audio output to the analog audio input on the the soundbar (left and right RCA jacks). The analog audio output on your TV will be a 1/8 inch stereo minijack or a pair of RCA jacks. The two illustrations below show the appearance of these two audio output connections.

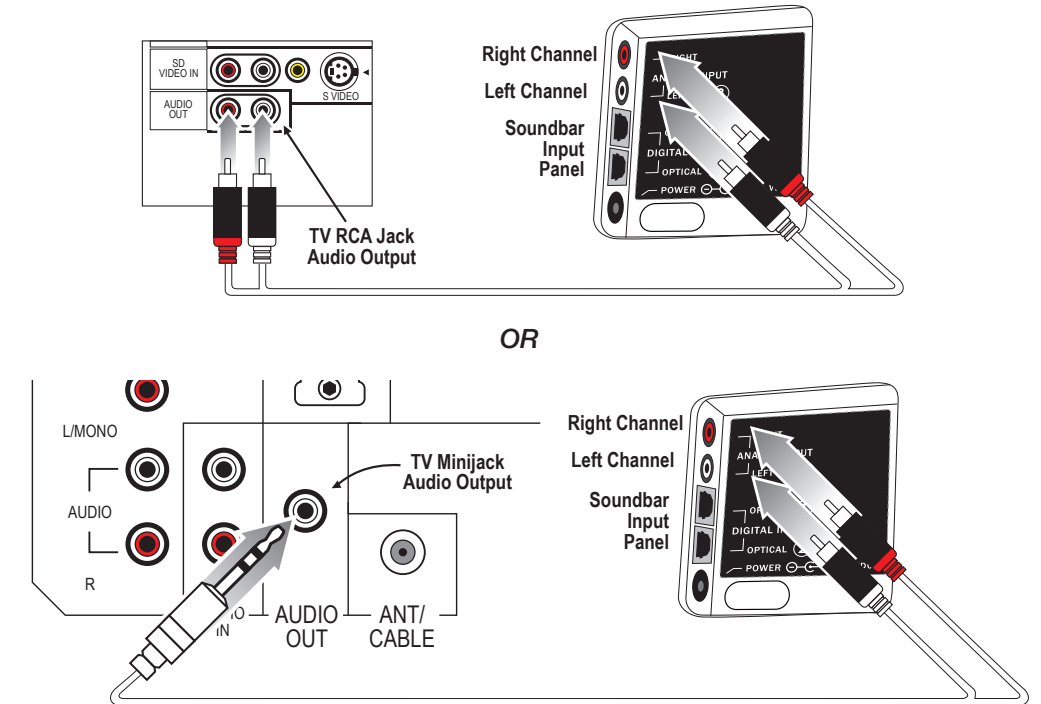

Second Digital Input

The optical audio output of a second audio source (Bluray/DVD player, for example) can be connected to optical input 2 on the soundbar. It is selected when you see In2d on the soundbar display.

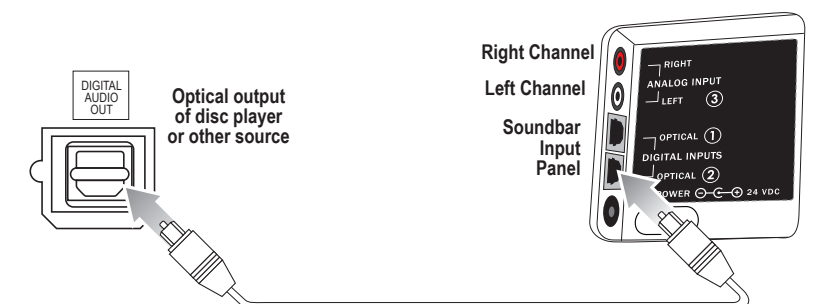

If You Have A Coaxial Digital Audio Signal Source:

This ZVOX Audio soundbar does not have a coaxial-format digital audio input. A coaxial digital to optical digital audio converter OR a coaxial digital to stereo analog audio converter should be used. Contact ZVOX Audio at info@zvoxaudio.com to learn what suitable audio converters are available.

3. Connect the power supply adapter

FIRST, connect the DC plug of the power supply adapter to the DC IN jack on the back of the soundbar. THEN connect the AC plug of the power supply adapter to an unswitched AC power outlet.

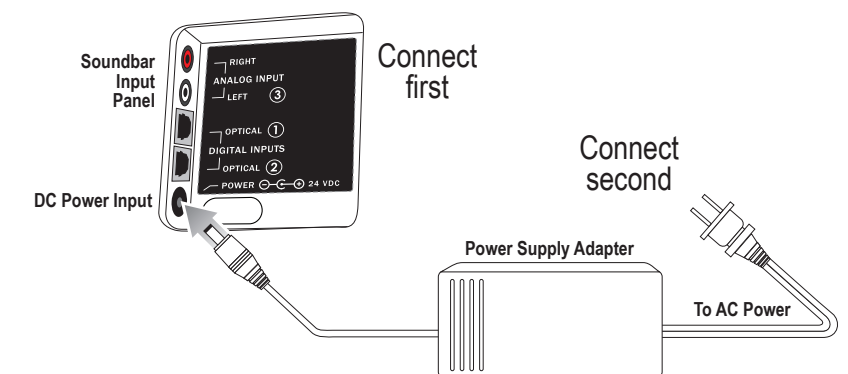

If your home TV system does not match the descriptions in this guide, don't hesitate to send an inquiry to info@zvoxaudio.com or call ZVOX Audio at (866) 367-9869. Please provide your TV brand and model number. A ZVOX Audio representative should be available (Eastern Time Zone) 9:30 AM to 7:30 PM Monday through Friday.